

# Newsletter

# 13

MLZ is a cooperation between:

Bavarian State Ministry of  
Education, Science and the Arts



SPONSORED BY THE



Federal Ministry  
of Education  
and Research

**The Heinz Maier-Leibnitz Zentrum (MLZ):**

The Heinz Maier-Leibnitz Zentrum is a leading centre for cutting-edge research with neutrons and positrons. Operating as a user facility, the MLZ offers a unique suite of high-performance neutron scattering instruments. This cooperation involves the Technische Universität München, the Forschungszentrum Jülich and the Helmholtz-Zentrum Geesthacht. The MLZ is funded by the German Federal Ministry of Education and Research, together with the Bavarian State Ministry of Education, Science and the Arts and the partners of the cooperation.



## Expanding capabilities

During the last years, the number of staff permanently working at the FRM II and MLZ was continuously growing. Today about 320 persons work on site and we expect this number even to grow within the next years. To accommodate all these persons we had to install container offices and to rent office and laboratory space at the neighbouring Max-Planck-Institute for Plasma Physics as interim solution. Furthermore, we seriously lack laboratory and workshop room for the science as well as for the reactor operation division. To overcome this unfavourable situation, we started construction work in August this year. On the west side of the FRM II ground, two old laboratory and office buildings dating from the early days of the “Atomic Egg” were torn down. This frees the necessary space for two new buildings providing offices as well as laboratory space and workshop areas.

On the south side of this area, the Forschungszentrum Jülich will construct an office and laboratory building. On the north side, with similar dimensions, the TUM building will comprise a large workshop shed for the reactor operation division and two floors with offices. The two four-storey buildings will have an area of about 50 m x 20 m each. A total of about 190 working places will be available in the office areas.

Both buildings will be realised by the Bavarian public construction authority (“Bauamt”) at Rosenheim. Meanwhile, a walkable supply route for the two new buildings is under construction and will be finished by the end of this year. We expect to use our new buildings with fully operational laboratories by the end of 2018. The total cost of this construction project is about 30 Mio € – they go share on the MLZ partners TUM/ FRM II and Forschungszentrum Jülich.



*Klaus Seebach*

*Dr. Klaus Seebach*  
Administrative director FRM II



# Content

## Instrumentation

PANDA: 3.5 bar at 0.5 k .....	5
The multianalyser device at PUMA.....	6
New hall for cooling systems of the UCN source .....	8
At the MLZ breaks are no holidays! .....	10

## Events

JCNS Workshop 2014 .....	14
SNI 2014 .....	15
Jana2006 .....	15
Denim 2014 .....	16
18 <sup>th</sup> JCNS Laboratory Course Neutron Scattering.....	16
Lego, neutrons and cool T-shirts .....	17
Neutrons for the public .....	17
MULTI-TAS .....	18
McPhase .....	18
VDI Expertenform 2014 .....	19

## Science & Projects

EEBATT explores decentralised stationary energy storage solutions .....	20
Bridging the gap between X-rays and neutrons @ STRESS-SPEC .....	22

## Outside

A short review of the work of the 9 <sup>th</sup> KFN - and new tasks for the 10 <sup>th</sup> KFN! .....	24
---	----

## Inside

Nothing to fear for an engineer.....	25
Both instrument scientists newly arrived at RESEDA!.....	26

## User Office

Don't forget to register for the MLZ User Meeting 2015! .....	27
Joint forces: Visitors' Service and User Office merged.....	28
Don't forget to submit your proposal!.....	29
Upcoming .....	30
Reactor Cycles 2015 .....	30
Imprint.....	30

Don't miss the Proposal Deadline  
**Januar 16<sup>th</sup>, 2015**  
 page 29



## PANDA: Reaching 3.5 kbar at 0.5 K

Using a new gas pressure cell for the first time

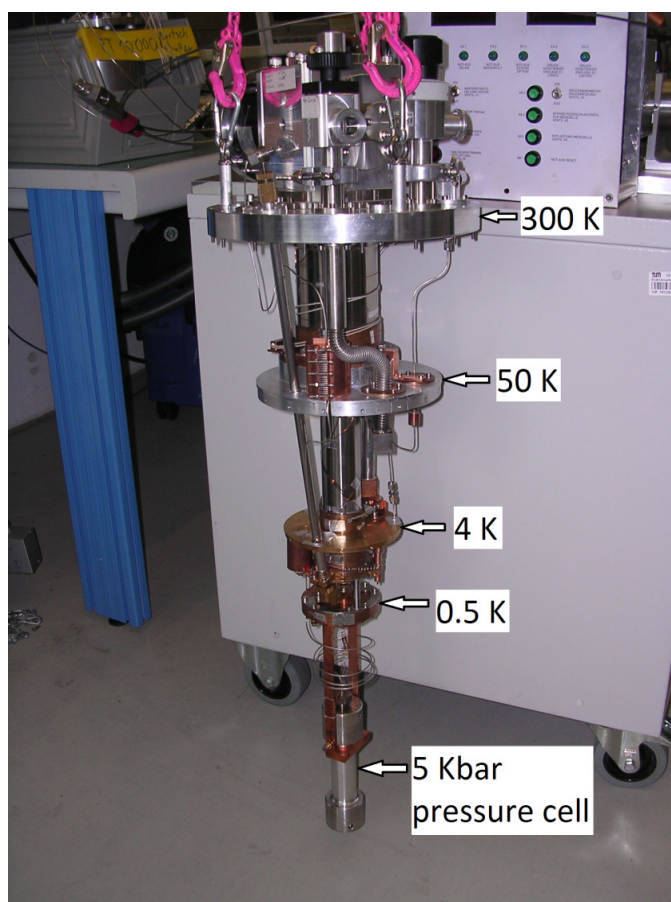

The new pressure cell.

Physicists all over the world were always interested in studying how properties of compounds changes with changing of external conditions like temperature, magnetic field, or pressure. Under applied pressure, the interatomic distances in magnetic solids shrink and influence directly the microscopic interactions. A combination of both high pressures and low temperatures enable us to create exotic phases of quantum matter in newly studied materials. One such sample is  $\text{Cs}_2\text{CuBr}_4$ , a quasi-1

dimensional quantum antiferromagnet. At ambient pressure, the magnetic moments develop long range order – a so-called spin spiral state. It is expected that this classical order gets suppressed when the right amount of pressure is applied and gives way for more exotic quantum states, like resonating valence bond spin liquid. Neutrons are the unique probe to determine the properties of the new phase, and the PANDA neutron spectrometer is suited for that determination.

The new pressure cell together with the in-house developed  $^3\text{He}$ -cryostat enable us to continuously tune pressure at low temperature without being forced into heating up the sample and thus allowing systematic pressure studies on sensitive systems. The pressure cell and the pressurising device is supported and operated by Andreas Buchner of the group Sample Environment. The cryostat is designed, built, and operated by his colleague Heinrich Kolb.

These extreme values of pressure together with low temperatures were reached for the first time at a neutron facility using a gas pressure cell. Such an experiment can only be the result of an excellent cooperation: It was the teamwork of MLZ sample environment, instrument scientists, engineers, and an external user.

*The PANDA team*



After the successful change of pressure (left to right): Sándor Tóth, Florin Stoica, Heiner Kolb, Andreas Buchner, Petr Čermák, and Astrid Schneidewind.

## Novel type of polarisation analysis

The multianalyser device at PUMA

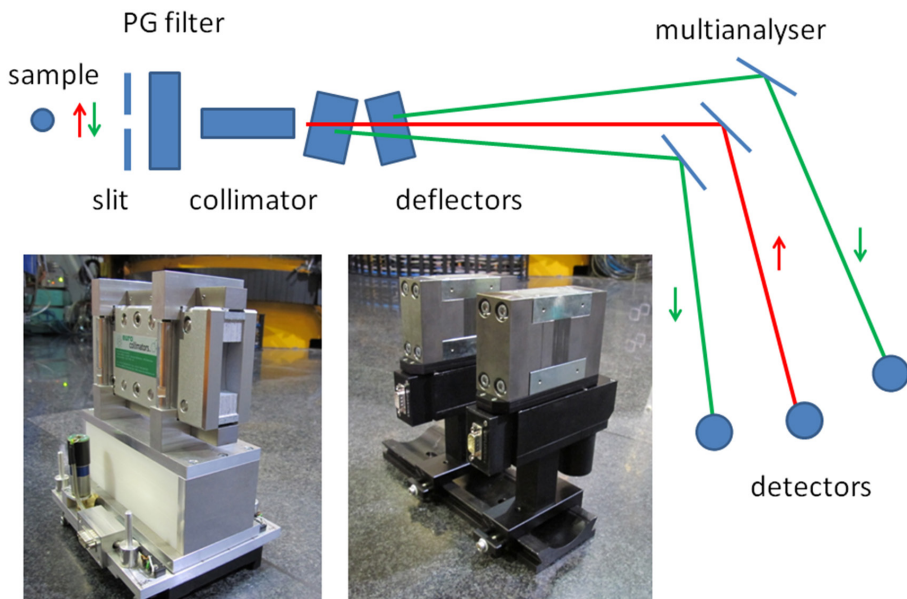

Fig. 1: The layout of the PUMA multianalyser polarisation analysis system. The collimator (left inset) and defectors (right inset) are equipped with micro-step motors for alignment.

Polarisation analysis is probably the most time consuming technique in neutron scattering. This is not only because polarisation of neutrons always costs intensity, but also due to the necessity of spending time for the measurement of spin-flip and non-spin-flip scattering channels. The recently commissioned multianalyser system of PUMA in combination with polarisation analysis option could save expensive beam time, since it allows for measuring spin-up and spin-down scattering simultaneously using a special combination of polarisers (deflectors). This option will be especially useful for kinetic experiments, because the spin-flip and non-spin-flip scattering can be measured at exactly the same experimental conditions.

The layout of polarisation analysis of the scattered beam is shown in fig. 1. Multilayer stacks (deflectors) consisting of FeSi polarising supermirrors on Si-wafer substrate (SwissNeutronics,  $m = 4.5$ ) are used as polarisers. Two deflectors are needed in order to take into account the divergence of the scattered neutron beam. They are oriented in the scattered beam at critical angle  $\theta_c$  ( $-\theta_c$ ), so that the neutrons polarised in parallel direction ( $\uparrow$ ) are transmitted, whereas neutrons with spin-down polarisation are reflected. Both components hit different analyser blades of the PUMA multianalyser system where the neutrons are reflected and

sent towards the corresponding detectors. Hence, both polarisation channels can be recorded simultaneously in different multianalyser channels. An additional collimator is used to improve the performance of this set-up on the expense of some intensity. The typical three axes measurements are predominantly performed using a constant  $k_f$  mode. This means that the deflectors are supposed to be calibrated for only one wavelength ( $k_f = 2.662 \text{ \AA}^{-1}$ ), and any kind of corrections can easily be introduced.

First test experiments were performed recently proving the principle of this innovative method (fig. 2). The simplified set-up was used: Instead of the multianalyser system we used a position sensitive detector (PSD) in order to see the angular distribution of neutrons scattered by the sample behind the deflectors. The incoming neutron beam was polarised by a  $^3\text{He}$  filter. Elastic

scattering from different samples (germanium, vanadium,  $\text{Fe}_2\text{O}_3$ ) was measured with neutrons wave vector  $k_i = k_f = 2.662 \text{ \AA}^{-1}$  aiming to check the performance of the system depending on different experimental conditions, such as sample size, collimation, guide field, etc., and in order to find the most optimal configuration for the multianalyser system.

The intensity distribution of the non-polarised incoming beam (no  $^3\text{He}$  filter) scattered by the germanium sample is shown in fig. 3. The central peak corresponds to the transmitted spin-up neutrons, whereas two side

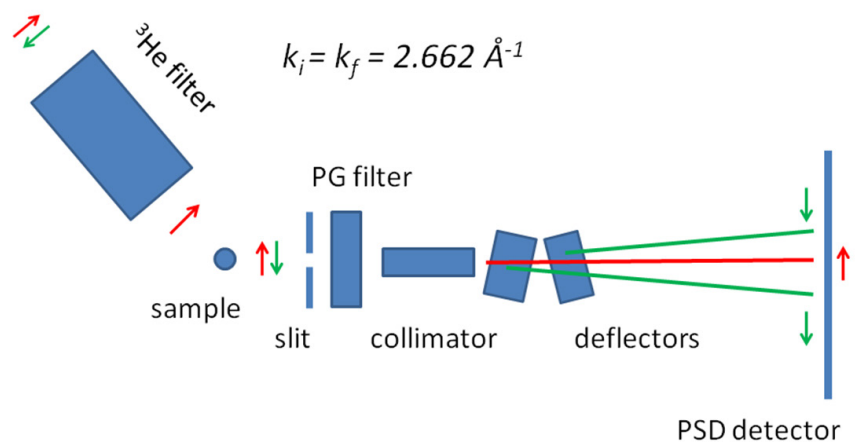

Fig. 2. The layout of the first test experiment.



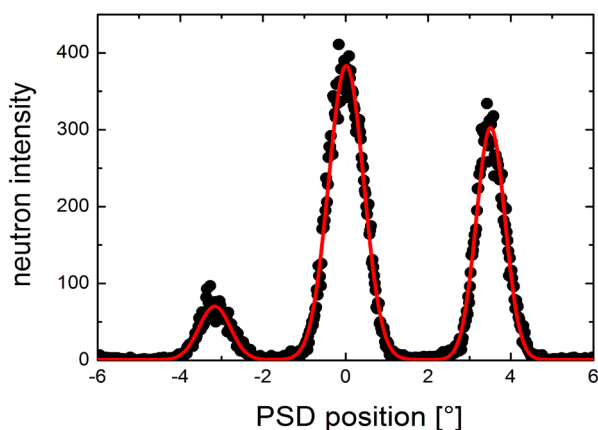

Fig. 3. Bragg scattering of non-polarised neutrons from the germanium sample.

The symmetric configuration, however, is less optimal in terms of intensities ratio ( $I_{\text{ref}}/I_{\text{trans}}$ ). This result also means that the collimation can be significantly relaxed (30') for our forthcoming experiments.

Fig. 4 shows the Bragg intensity from the hematite ( $\text{Fe}_2\text{O}_3$ ) sample measured by the PSD detector. In the case of nuclear reflex (006) only the non-spin-flip (transmitted) signal is recorded, whereas the anti-ferromagnetic scattering (003) shows both signals: transmitted and reflected corresponding to the spin-flip and non-spin-flip channels. As expected, if we switch on a flipper (fig. 4, on the right), the transmitted signal from (006) reflex disappears, and reflected intensity shows up.

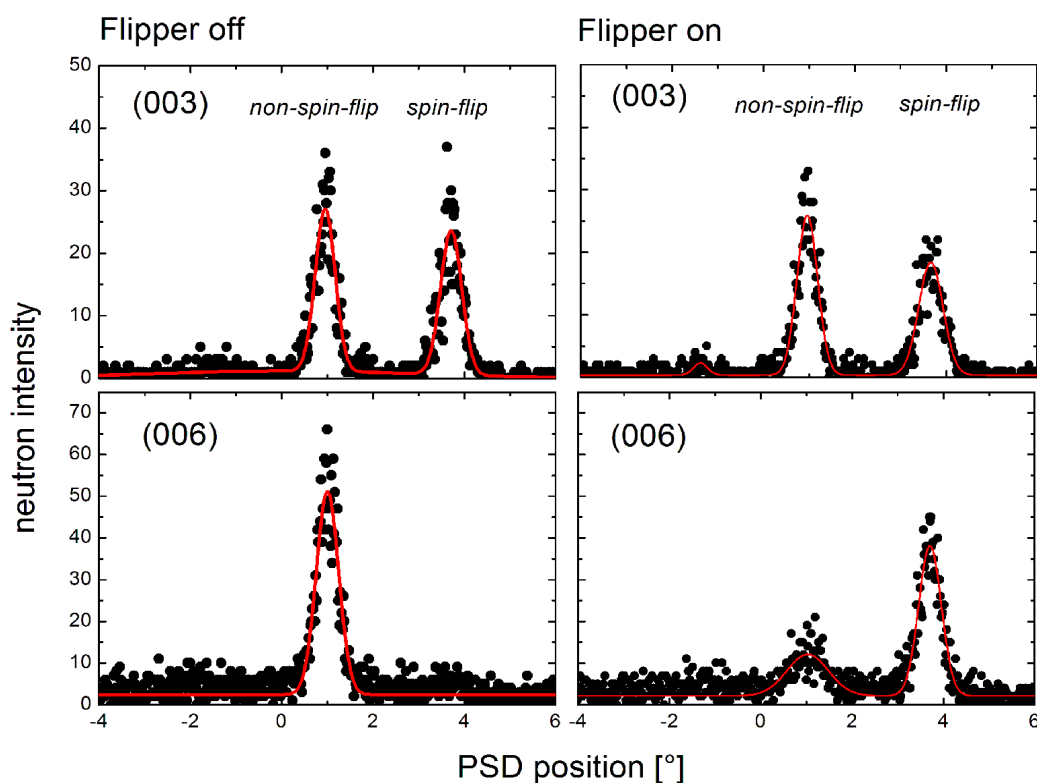

Fig. 4: Bragg scattering from the hematite ( $\text{Fe}_2\text{O}_3$ ) sample: nuclear reflex (top) and anti-ferromagnetic reflex (bottom).

peaks are reflected spin-down neutrons. These signals show a very good separation, therefore they can easily be detected by the multianalyser system. The intensity ratio  $I_{\text{ref}}/I_{\text{trans}} = 0.83$  demonstrates a very high efficiency of the deflectors. Due to the rather tight collimation (15'), most of spin-down neutrons are collected by the first deflector and the second reflected peak (fig. 3, on the left) is much smaller than the first one. In principle, one can align the deflectors in such a way that they would produce a more symmetric reflected signal.

The first results using the double deflector system clearly show that the novel method for simultaneous determination of spin-flip and non-spin-flip channels works. Also, preliminary tests with the multianalyser have shown that the spatial separation of the signals can be successfully combined with the wavelength selection. We expect that the thorough characterisation of all features of this technique along with the normalisation of the individual intensities can be performed within the next months. Hence, the polarisation option at the PUMA three axes spectrometer will become available for users with in 2015.

*G. Eckold, S. Schwesig, O. Sobolev  
(Georg-August-Universität Göttingen)*



## New hall for cooling systems of the ultra-cold neutron source

The ultra-cold neutron (UCN) source of the FRM II will be installed in the tangential end-to-end beam tube SR6. To slow down thermal neutrons, a solid deuterium converter, together with a solid hydrogen pre-moderator, at a temperature of 5 K will be inserted into the SR6 beam tube. To cool these two media down to 5 K, large cooling machines, with a peak power of 1 kW at 5 K, have to be installed.

South of the Maier-Leibnitz Laboratory, a hall in wood construction is currently being built. From next year on, it will house the mock-up for the cooling systems of the ultra-cold neutron source. The hall was necessary in order to be able to test the large cooling systems of the ultra-cold neutrons' source in non-nuclear operation. Only after a year of testing, the compressors and gas tanks will be taken to the neutron source for the preparation of ultra-cold neutrons.

The foundations for three gas tanks, filled with the coolants nitrogen and helium, are already poured. The 70 m<sup>2</sup> wide and 3.70 m high hall consists of a wooden structure. It will house the compressors of the refrigerator, which is to ensure the cooling of the neutrons. The construction of the wooden hall has been finished by the end of November, and currently the infrastructure, like electricity and cooling water for the compressors, is being installed.

The cooling machines themselves are located inside the Maier-Leibnitz Laboratory, and are already in place. Two conventional cooling machines with a power of 500 W at 5 K remove the heat from a closed cooling cycle of supercritical helium. This closed loop is connected with cryogenic transfer lines to a small vessel, housing the solid deuterium and the solid hydrogen.

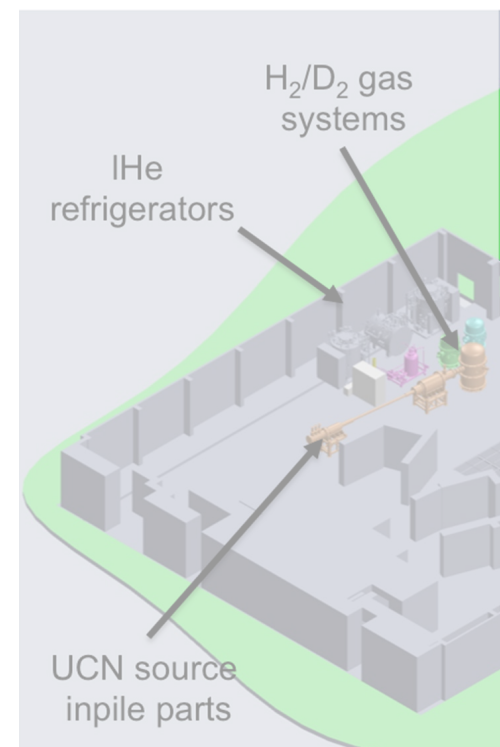



The ultra-cold neutrons are slowed down by this cooling so much that they have a velocity of only about 20 kilometres per hour. Planned experiments with ultra-cold neutrons include e.g. the measurement of the lifetime of free neutrons, the search for an electric dipole moment of the neutron or the measurement of quantum states of neutrons in the earth gravitational field.

*A. Frei (FRM II)*

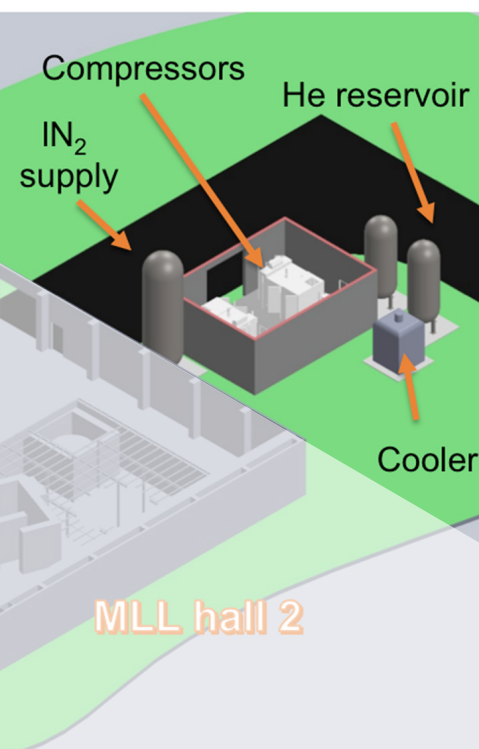



## At the MLZ breaks are no holidays!

In 2014, the FRM II reactor underwent the 10-year planned maintenance and it was not in operation for about six months from February through August 2014. During this time the MLZ staff was working hard to upgrade the instruments and introduce technical improvements for the benefit of the users. At the moment, some other instruments are still in the final steps of their upgrade and we will report about them extensively in the next MLZ Newsletter.

### KWS-3

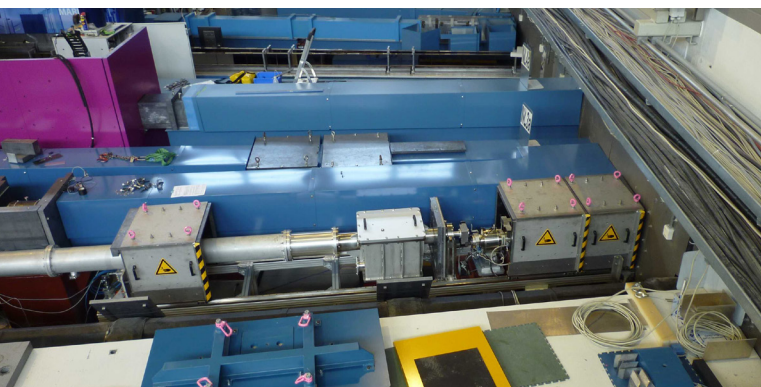

Fig. 1a: New mobile shielding installed at KWS-3.

Three major steps forward have been introduced at the very Small Angle Neutron Scattering diffractometer KWS-3.

#### Upgrade of selector area

Due to historical reasons, the KWS-3 instrument was moved to the MLZ without full adaptation to the conditions at the new place. Therefore, due to this “conditional movement” the selector area of KWS-3 included only a temporary solution for the shielding of the neutron guides. Thus, the selector area has been completely re-designed and new options have been integrated for the benefit of the users:

- The new shield is installed on rails (fig. 1a) and can be moved into the range of the crane with a much easier maintenance work at the instrument.
- The selector can be aligned in the x-y plane and rotated; a sketch of the alignment system is shown in fig. 1b. The wavelength resolution  $\Delta\lambda/\lambda$  now can be varied between 18 and 30% with the rotation of the selector.
- The polariser chamber and its positioning system are integrated for future upgrades.

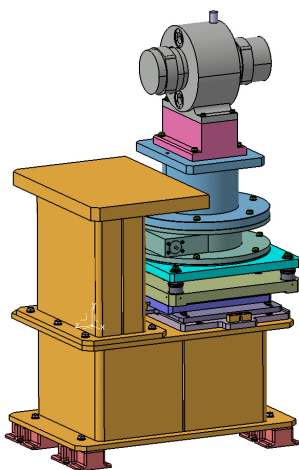

Fig. 1b: Design of “easy” alignment of selector at KWS-3.

- A motorised aperture before the selector is implemented in order to tune the background.
- A small chopper is now available for a TOF operation mode.

#### Bulky sample environment

The initial conception of KWS-3 instrument was based on the absence of windows between the entrance aperture and the detector, with two vacuum-sample-chambers (9.5 and 1.3 m away from the detector) integrated between the mirror and the detector. Due to the limited space at the sample position, experiments with *bulky* sample environments like magnet, rheometer, or stopped-flow device were excluded from KWS-3 instrument. We have now developed a *mobile* sample position to accommodate *bulky* sample environment between 2 and 8 m from the detector depending on the requested instrument resolution. The air gap between the two sapphire windows varies from 10 cm to a few meters. The new sample position is shown with the space for a 2-Tesla electromagnet (fig. 1c) and with a rheometer (fig. 1d).



Fig. 1c: Place for 2 T vertical electro magnet at the KWS-3 sample position.



Fig. 1d: Rheometer is ready for next sample at KWS-3.

#### New very high-resolution detector

Resolution of a focusing SANS instrument is defined by the instrument geometry, the entrance aperture size, the wavelength, and the detector resolution. With the old high resolution detector, the minimum Q value accessible [ $Q_{\min} = 10^{-4} \text{ \AA}^{-1}$ ] at the KWS-3 is reached under the following configuration: sample-to-detector distance 9.5 m, wavelength 12.8 Å and entrance aperture  $2 \times 2 \text{ mm}^2$ , and cannot be extended to lower Q values by decreasing the entrance aperture due to the limitation of the detector resolution. A new very high-resolution detector, with about three times better resolution, was developed by our detector group and tested at KWS-3. The new very-high resolution detector, together with an entrance aperture of  $0.7 \times 0.7 \text{ mm}^2$ , has allowed us to extend the Q range down to  $Q_{\min} = 3.5 \times 10^{-5} \text{ \AA}^{-1}$ , and it will become available for internal as well as for external users from the beginning of 2015.

V. Pipich (JCNCS)



## NEPOMUC

Besides the spectrometers and the beam lines to the instruments, in particular two main parts – the NEPOMUC source itself and the positron remoderator – received overhaul from which all attached instruments benefit.

The positrons, which are created and moderated in the platinum foils of the in-pile positron source, are extracted and accelerated by a set of different electric lenses floating on high voltage. Therefore, well-defined electrical potentials of the head section of the positron source are crucial for the positron extraction and beam formation. During the last ten years of operation, this important task was performed reliably using two central high voltage supplies and a “HV Offset Box” which was a valuable custom development at the electronic workshop of the physics department. However, the electronic components showed first signs of deterioration of its long-term stability during the last reactor cycle. For this reason, these parts were replaced by the new high voltage equipment. Besides the regained reliability of the source operation, the new components are computer controlled and are integrated into the central beam line control software. This allows an automatic optimization of the high voltage settings for positron beam transport. Hence, this option greatly facilitates the usage of the primary positron beam at different energies for planned experiments, such as, for example, at the open beam port.

The remoderation device of NEPOMUC enhances the brightness of the positron beam and hence enables positron experiments, which are highly resolved in the space and/or time domain. The remoderator is based on the stochastic cooling of the positrons in a W(110) single crystal and the positron reemission of the thermalized positrons into the vacuum with discrete energy. During the last years, the used crystal degenerated and was therefore replaced. Within this procedure the crystal clamping system was reconstructed in order to account mainly for two issues. First, higher temperatures can be achieved by flashing the crystal using a new designed current heating. This is required to increase the positron moderation efficiency by removing adsorbates from the crystal surface. Second, the system is now reusable for the test and application of new promising remoderating materials.

In addition to the remoderation itself, a distortion-free transport of the remoderated positron beam right from the beginning is of high importance. For this reason, the existing magnetic field coils and their feed lines were rearranged. Furthermore, new magnetic correction coils were mounted at the remoderator, which are used for an optimized injection of the remoderated positrons into the magnetic guiding field. As a result, the beam quality was enhanced and e.g. the entrance aperture at the **Coincidence Doppler Broadening Spectrometer (CDBS)** could be reduced again by a factor of four without losing counting rate at the detectors. Therefore, the measurement time of experiments where a high spatial resolution is required could be reduced. At the **Pulsed Low Energy Positron System (PLEPS)** the benefits are comparable but in the time domain. I.e. the timing resolution and more important the peak-to-background could be further enhanced.

In addition to that, the whole UHV system of the beam line and the positron instruments was maintained. Several instruments have been upgraded as well. At the CDBS new devices were installed in order to allow the variation of the distance between the high purity Germanium detectors and the sample as well as the positioning of two larger pixelated Germanium detectors. At the surface spectrometer several parts have been replaced (e.g. a not well aligned linear feed through) or newly installed, such as a new coolable and heatable sample stage, which allows the orientation of the sample with highest accuracy.

*Ch. Hugenschmidt, Ch. Piochacz, S. Vohburger  
(TUM)*

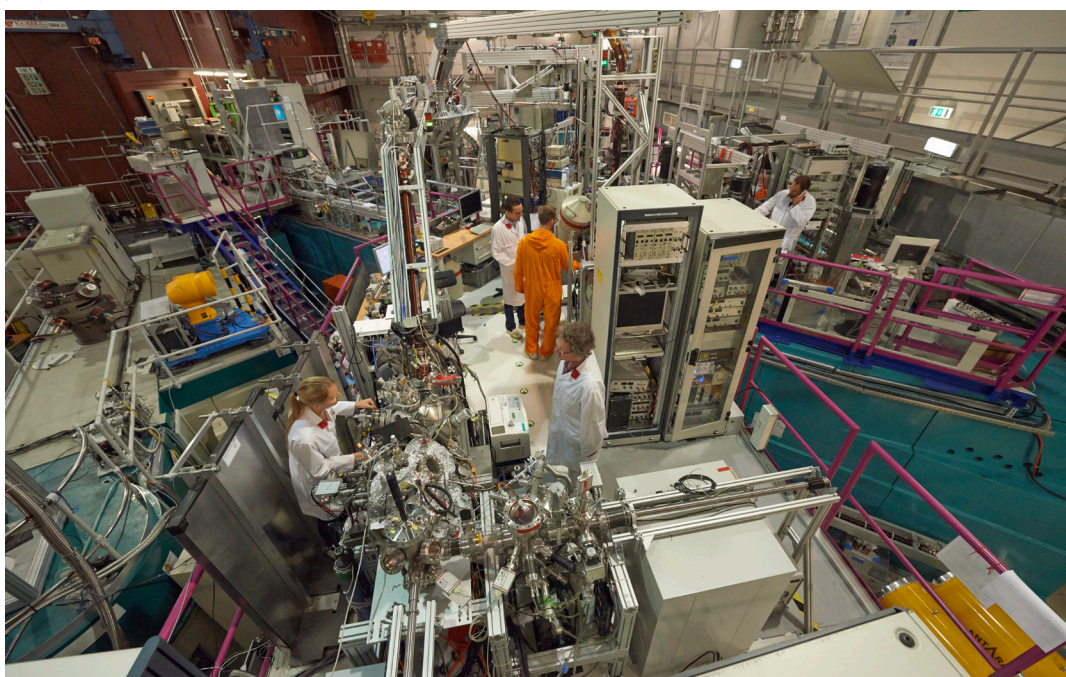

Fig. 2: The positron beam facility and instruments at NEPOMUC.

## PGAA

Prompt gamma activation analysis (PGAA) is based on the detection of so-called prompt gamma rays emitted by atomic nuclei absorbing neutrons. Irradiation and gamma-ray counting takes place at the same time, thus the instrument needs a double shielding, against cold neutrons and against gamma radiation emitted by the structural materials so that the useful signal, i.e. the induced gamma radiation from the sample is stronger than radiation from any other sources.

We have been working on the shielding of the PGAA instrument for many years gradually lowering the intensity of the beam background. The latest construction is a tricky combination of lead to attenuate gamma radiation, boron- and lithium-containing shielding materials used against neutrons. Both boron and lithium-6 have to be used, as none of them are ideal: boron emits 478-keV gamma photons when absorbing neutrons, while lithium-6 emits no gammas, but charged particles (alphas and tritons) instead, which produces fast neutrons in a secondary reaction. Fast neutrons cause drastic neutron damage in the germanium crystal of the detector, and in high-flux beams, like ours, it destroys the detector in just a few weeks, when the beam is stopped using lithium-containing absorber. Thus, lithium cannot be put in direct beam; however the surface of the sample chamber is covered with lithium-containing plastic sheets. The beam is collimated and stopped using boron-containing materials (boron rubber, boron carbide), while the gammas emitted by it are stopped in few centimetres of lead.

The shielding is constructed in a way that all the radiation is caught where it is born. For that purpose, the chamber arrangement proved to be the most useful approach, i.e. all units are like separate chambers joining to each other through small “windows”. The first unit is the guide chamber, containing the elliptical neutron guide, which is interchangeable with a collimator. The unit is covered with boron rubber and is placed on a moveable platform on a cantilever. The whole block is covered with 10 - 15 cm of lead. The next unit, the central chamber is surrounded by lead walls, the neutron beam goes into the sample chamber, an aluminium tube covered with lithium-containing plastic sheets, and then it is stopped in the beam stop. These units are covered with 10 - 15 cm of lead. Perpendicular to the beam direction, a lead collimator lets the gamma rays into the germanium detector, which is surrounded by an active shielding, the so-called Compton-suppressor to reduce the spectral background originating from the photons scattered out of the detector, and also with a passive shielding: a 15 cm thick layer of lead. The arrangement can be seen in fig. 3.

The total count rate in the spectrum while acquiring the room background is about 5 counts per second, but it highly depends on the operation of the reactor and the neighbouring instruments. When we switch on the collimated beam with the flux of  $2 \times 10^9 \text{ cm}^{-2} \text{ s}^{-1}$ , the count rate increases by about 10 counts in a second, which enables the use of more than 3 orders of magnitude for the useful signals, as the spectrometer can handle about 30,000 counts per second. This low background allows for the irradiation of samples with masses of milligrams already in the collimated beam.

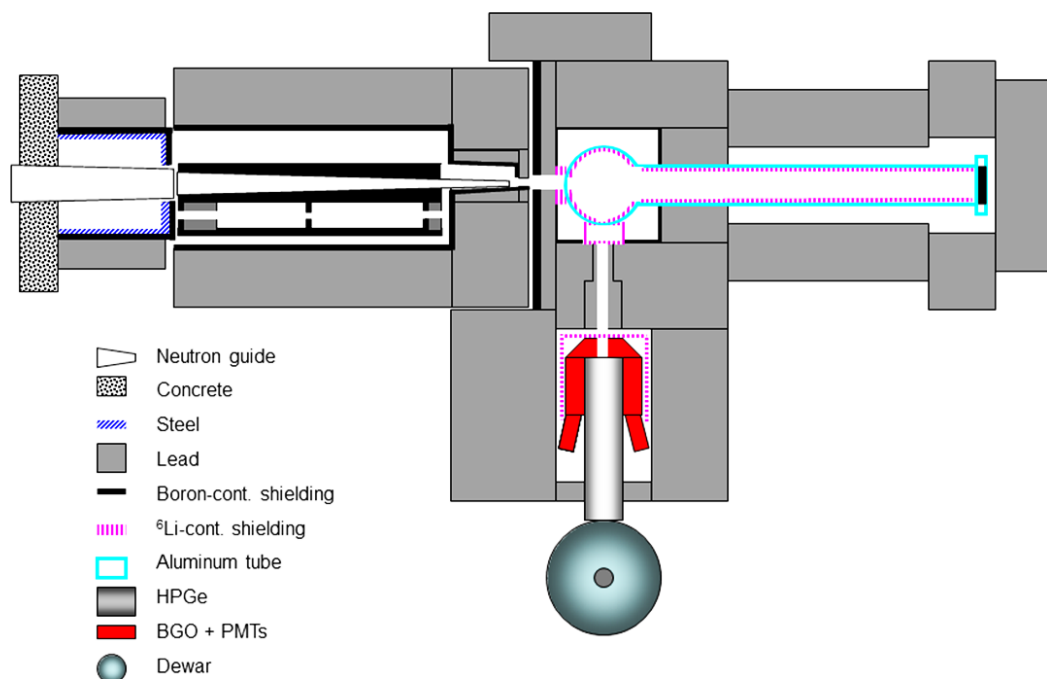

The high-flux beam is about 20 times stronger than the collimated one. The elliptical guide produces a highly divergent beam, which activates more structural materials, so that the background is not scaling up proportionally to the flux. The best background count rate so far was about 400 counts per second offering two orders of magnitude for the signal. We are working on its improvement.

*Z. Revay (FRM II)*

Fig. 3: Shielding arrangement at PGAA.



## POLI

For single crystal diffraction the precise centering of the sample in a common center of rotation of the involved axes is extremely important for the data quality. It was found that for different cryostats significant deviations can occur especially at low temperature if the sample is simply centered within the sample tube of the cryostat. The entire cryostat was moved and tilted in order to achieve a desired orientation of the sample. Thereby, the free moving space was limited, especially with the cryostat inside the Cryopad, and often it was difficult to reach the required orientation. A non-magnetic positioning system inside the cryostat using Atto-cube piezomotors could overcome this drawback and significantly increase the precision and flexibility in the sample manipulation in the beam under very low temperatures.

Therefore a new positioning stage to position a sample in the neutron beam while being fixed inside the cryostat and cooled down to 4 Kelvin was developed. The device enables a fast and precise positioning of the sample in the Cryopad.

The newly developed positioning stage is shown in fig. 4 and consists of several piezoelectric motors (2), which enable a positioning and rotating of the sample (1) directly in the beam. A new guidance (3) secures the centering of the sample in the center of rotation, even at low temperatures. The device can be adjusted in height (4) so that different piezoelectric motors can be used.

Furthermore, an optical camera allows a fast and accurate positioning of the sample on the sample stick before mounting it in the cryostat. The sample stick is mounted on a tube with the same inner diameter of the cryostat. By measuring the displacement between the center of rotation and the sample while turning the sample stick, the sample can be aligned, so that valuable testing time at the neutron beam can be used more effectively.

To validate the results, extensive tests were performed at POLI. The sample stick, with a positioned sample, was inserted into the cryostat. A neutron camera measured the deviation from the rotation axis both while turning the stick inside the cryostat and while rotating the cryostat. The sample had a maximum displacement of  $\pm 0.1$  mm out of the center, even at low temperature. The piezoelectric motors were used to orientate the sample into desired crystallographic plane with up to an accuracy of  $0,01^\circ$ . The total available tilting angle is limited by the selected piezoelectric motors to  $\pm 3.3^\circ$ .

The new positioning device enables new options of handling samples and is available for users at POLI and other instruments using single crystal samples at the MLZ.

This work was part of the master's thesis of P.Schmalen, supervised by V. Hutanu (RWTH Aachen, Germany) and F. Irlinger (TUM, Germany), and was supported by the FRM II Sample Environment group.

*V. Hutanu, P. Schmalen (RWTH Aachen)*

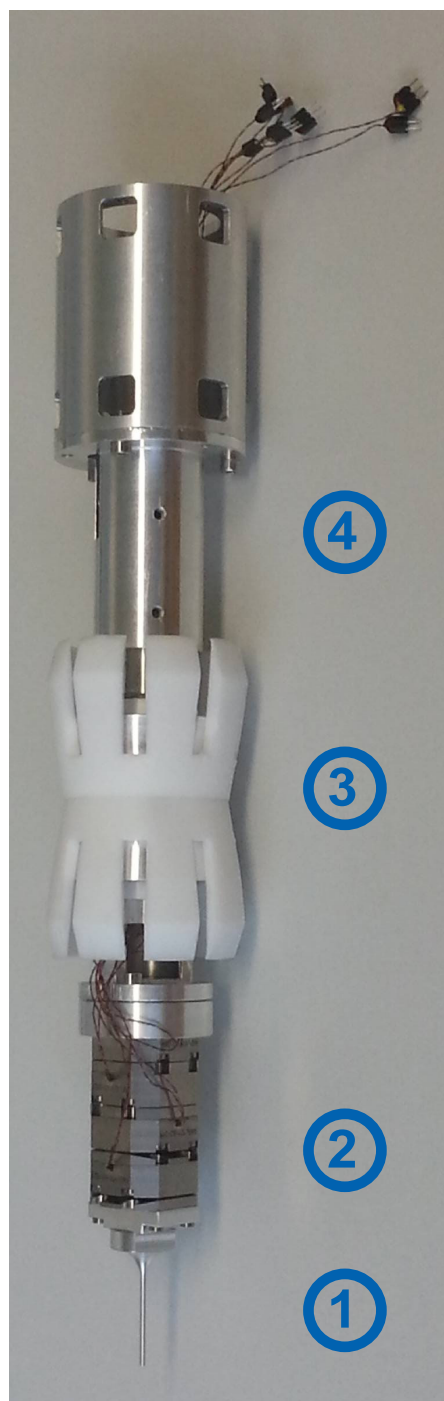

Fig. 4: The new sample positioning stage at POLI.

*Collected and combined by F. Carsughi (JCNS)*



## Attracting key experts and specialists to the JCNS workshop

Tutzing: October 20-23, 2014



Since 2007, the Jülich Centre for Neutron Science (JCNS) of Forschungszentrum Jülich, Germany, holds the 3-year cycle of annual workshops on “Trends and Perspectives in Neutron Scattering” in neutron instrumentation, soft matter and magnetism.

This year, JCNS workshop held in Tutzing, Germany, from October 20<sup>th</sup>-23<sup>rd</sup> has opened the 3<sup>rd</sup> cycle and was devoted to the challenges for and perspectives of continuous neutron source in the light of the incoming European Spallation Source (ESS). The ESS is opening breathtaking possibilities, as the flux at its instruments will exceed the flux of similar instruments at MLZ or ILL by more than an order of magnitude. However, this outstanding perspective does not diminish the value of the existing continuous neutron sources. The double-digit gain in intensity at the ESS will not directly result in the same gain in the experimental time, but will be used for flagship experiments aiming weaker effects at smaller samples, so that the time per experiment will be like at present. Therefore, the existing network of neutron sources will further be of an indispensable value allowing for a large number of standard for today experiments and thus supporting and keeping the large neutron user community that is vitally important for the successful scientific life of the ESS as well.



In the same time the ESS at the horizon is a trigger to intensify today's instrumentation upgrade to narrow the above mentioned intensity gap. Moreover, three years of enormous intellectual efforts of the neutron community, both users and instrument scientists, aiming the

definition of new instrumental challenges via science cases and developments of the instrumental concepts for the ESS resulted in new ideas and approaches, which cover the whole neutron tract (target, cold sources, neutron delivery systems, instrument components and instruments themselves). This stockpile of knowledge can be fruitfully used for the improvement of the existing instrumentation.

55 scientists answered the call and attended the workshop. Their thirty invited and contributed presentations and twelve posters made an intensive workshop programme. JCNS contributed in total nine oral presentations and six posters, underlining the key role of JCNS in advanced neutron instrumentation. The charming location of the Evangelische Akademie in Tutzing, together with the enthusiasm of the highly motivated attendees from Europe, USA, and Australia, created a stimulating atmosphere which resulted in numerous discussions throughout. The topical sessions were chosen to span the whole field of neutron instrumentation covering “new concepts in instrumentation”, “sources, shielding and guides”, “instrument components”, “advances in detectors”, “advanced sample environment”, and “new instrumentation at the ESS”.

Alexander Ioffe, the scientific organiser of the workshop stated:

*“We thank all the leading experts in the different fields for sharing their knowledge and results with us. With the European Spallation Source ESS and its outstanding perspectives in terms of fascinating new instruments becoming reality within the next years neutron instrumentation is in the focus of the community. We have seen excellent presentations throughout the workshop. The wide scope of topics initiated exchange between different communities and made the meeting a very fruitful one. I want to thank all attendees for coming to Tutzing and for their valuable contributions in terms of their talks, posters and discussions”.*

A. Ioffe (JCNS)



The next JCNS workshop (soft matter) will again be held in Tutzing from October 5<sup>th</sup>-8<sup>th</sup>, 2015.

[www.fz-juelich.de/jcns/JCNS-Workshop2014](http://www.fz-juelich.de/jcns/JCNS-Workshop2014)



## SNI 2014

Bonn: September 21-23, 2014



What a location! That was really a special feeling, being responsible for a conference booth presenting the MLZ in the World Conference Center Bonn during the German Conference for Research with Synchrotron Radiation, Neutrons and Ion Beams at Large Facilities. We put up our MLZ stand in the foyer directly in front of the Plenary Chamber, where the German Bundestag met between 1992 and 1999. The plenary talks as well as the public evening talks were held in this impressive hall. During the breaks, the more than 500 participants used the foyer for discussions, meeting colleagues, and last but not least eating the provided sandwiches.

Both poster sessions were also located in the space flooded with light, extending over the whole floor.

The public evening talks were held by Winfried Petry (MLZ) and Metin Tolan (TU Dortmund) and very well attended – we could even take the opportunity to inform many guests from outside about the MLZ. Guided tours of special poster sessions were offered to pupils, and in a Science Slam young scientists present their topics with a blinking. Thus, the importance of research with synchrotron radiation, neutrons and ion beams at large facilities became clear also to the interested public.

We were really happy to meet many users again – we had missed them during the maintenance break!

*I. Lommatzsch (FRM II)*



## Workshop Jana2006

Garching: September 18-19, 2014



W. Schürmann (TUM)

In the scope of the “International Year of Crystallography” this workshop and hands-on tutorial focused on Jana2006 was organised by the MLZ Group “Structure Research” on September 18-19, 2014.

The Jana2006 is a crystallographic computing system dedicated to the refinement/ determination of nuclear and magnetic structures of standard and modulated types. Its distinct features in comparison to other soft-

ware products are the use of superspace approach and magnetic space groups, thus enabling the determination of complex structures from both single crystal and powder diffraction data. Furthermore, a number of symmetry transformation approaches in reciprocal and superspace, the built-in charge flipping algorithm, anharmonic refinements and probability density function analysis, capability to handle merohedric twins as well as twins with partial overlap of diffraction spots, commensurate and composite structures etc. make it a powerful and sometimes non-alternative tool for the analysis of crystal and magnetic structures of diverse complexities.

About 20 participants of Heinz Maier-Leibnitz Zentrum, TUM Chemistry and Physics Departments took part in the workshop, where the authors of Jana2006, Václav Petricek and Michal Dusek from the Institute of Physics of Czech Academy of Sciences guided them through existing and newly developed capabilities of their software. The performed event received very positive feedbacks by the participants – they even proposed the organisation of a further workshop on Jana2006 in 2015.

*A. Senyshyn (FRM II)*

Find information at [jana.fzu.cz](http://jana.fzu.cz)



## Denim 2014

Ismaning: September 18-19, 2014



**Design And Engineering Of Neutron Instruments Meeting**, that is what DENIM means. Once a year, engineers involved in these topics get the opportunity to exchange experiences, come to know colleagues from other institutes dealing with the same problems, and discuss new ideas. The first meeting was organised by DENIM's initiators at home at ISIS (UK), the second one at SNS, Oak Ridge National Laboratory (USA), and – third time is a charm – at MLZ this year.

The sessions were dedicated to sample environment, motion systems, instrument development, sources, chopper systems, shielding, electronics, detectors, and project planning. A total of 22 talks dealt with the challenges in these fields, presented, and mooted solutions.

Nearly 100 participants accepted the invitation to Ismaning near Munich, arriving from neutron research centres all around the world, for example from ANSTO, ESS, ORNL, and NIST. Beside the work, they enjoyed a tour of the BMW World just before the conference dinner and took also part in the offered tours of the FRM II at the end of the workshop. The organisers managed to create an open and fruitful atmosphere during the whole meeting.

Next year, DENIM will make a stop at Budapest (Hungary) – all participants are looking forward to this!

*S. Staringer (JCNS)*

## 18<sup>th</sup> JCNS Laboratory Course Neutron Scattering

Jülich/ Garching: September 01-12, 2014



The 18<sup>th</sup> JCNS Laboratory Course Neutron Scattering took place on September 1-12, 2014. It started at Forschungszentrum Jülich for the lecture part and afterwards the whole group moved to Heinz Maier-Leibnitz Zentrum (MLZ) for the experiments.

The labcourse is open worldwide to students of physics, chemistry, and other natural sciences. The course is part of the curricula of the Universities of Aachen and Münster. Participation is free of charge. Financial benefit came from

Forschungszentrum Jülich with support from the EU projects NMI3, ESMI, and SoftComp.

The first week of the course was dedicated to lectures and exercises covering the technical basics of neutron scattering and selected topics of condensed matter research.

For the second week, eleven instruments at MLZ were made available for students' training. These world-class instruments are provided by Jülich Centre for Neutron Science (JCNS), Technische Universität München, University Göttingen, and Karlsruhe Institute of Technology.

This year 55 students were selected from 229 applicants. 18 foreign students came from a total of 13 countries. The number of participating female students – 29 – exceeded that of the male students: only 26.

The next JCNS laboratory course will take place on September 7-18, 2015. From January 2015 on, you are invited to submit applications at [www.neutronlab.de](http://www.neutronlab.de)

*R. Zorn (JCNS Jülich)*



## Lego, neutrons and cool T-shirts

Garching Herbsttage: September 13-14, 2014

The neighbours of the neutron source are curious: “Are you already producing the important radioisotope Molybdenum-99?” or “Where can I buy these Lego models?” were frequently asked questions at the industrial exhibition Garching Herbsttage in the vicinity of the FRM II. Since its first operation, the FRM II has had a booth at the biannual exhibition and has always been welcomed as the only participant from science among the numerous advertising enterprises from the community of Garching.

As already in 2012, the attraction for kids was the neutron ball toss. Yellow balls (neutrons) had to be thrown at blue balls (atoms) of about the same size

lying on small discs. One thing the children learned quickly from this scientific experiment: one does not always succeed. But Garching’s new mayor Dr. Dietmar Gruchmann cleaned up and won one of the much sought-after MLZ-T-Shirts with the slogan “Neutrons – hot, cold, ultracool”. In total, 60 happy children (and some adults) became owners of an MLZ T-shirt. The newest highlight for grown-ups as well as children were the two Lego models of a three axes neutron spectrometer and a time-of-flight spectrometer moving and blinking at the booth. Last but not least, the prominent location next to the entrance of the warm and bright Bürgerhaus was another guarantee for a high frequentation on a rainy, dark and cold September weekend.

A. Voit (FRM II)



## Neutrons for the public

Open day at Research Campus Garching: October 11, 2014

A new record in the history of open days at the FRM II: 505 visitors attended the guided tour of the FRM II on a warm and not too sunny October Saturday, when the campus Garching held its annual open day with a total of 10,000 visitors. Even students interested in Bachelor or Master theses visited the MLZ booth or scientists from other disciplines, who asked curiously about the measurements offered at the neutron source and how long a proposal takes to be accepted.

The booth of the MLZ was equipped with the neutron ball toss, the already known two lego models, a screen with films and animations running, many brochures and permanently three staff members. This was necessary as not only Lego fans were attracted to the booth and wanted to know details about neutron research or the mode of operation of the instruments. The position right next to the long line-up for the registration for a tour of the FRM II is still highly attractive as people can shorten their waiting time by gathering some information prior to their tour. The tours were fully booked by early afternoon.

The other booth of the FRM II radiation protection next to the entrance of the two main lectures halls was also well frequented. The radiation measurement equip-

ment and some examples for natural radioactivity were curiously regarded by the visitors and questions professionally answered by the radiation protection staff.

The talks addressed topics as the neutron source itself, the battery research, radioisotopes for nuclear medicine, high performance materials made of polymers and the ultra-cold neutrons. Some new topics were introduced by new speakers from MLZ and FRM II, who were sometimes astonished about how many people were interested in their subject.

Another lecture hall displayed short videos about the FRM II fuel element, the production of the radioisotope Lutetium-177 and some research topics addressed at the MLZ.

A. Voit (FRM II)

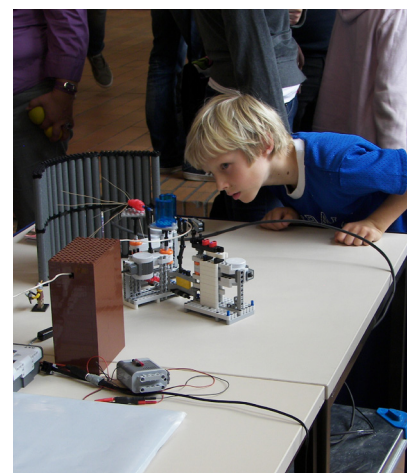

## Workshop MULTI-TAS

Garching: August 04-05, 2014

A small workshop about application of **Multi-Analyzer-Detectors** on **TAS** instruments took place at the MLZ in the beginning of August to discuss possible multiplexed analyser schemes for inelastic neutron spectrometers.

There were representatives from many different multi-analyser projects including BAMBUS (PANDA, FRM II, Garching), ESS CAMEA (EPFL, Lausanne, and Niels Bohr Institute Copenhagen), PSI CAMEA (PSI, Villigen) and Multi-FLEXX (FLEXX, HZB, Berlin). Whilst the respective projects have different goals and approaches, the main concept centres around a large combined analyser coverage to boost the data acquisition rate over a range of reciprocal space.

The aim of the meeting was to disseminate knowledge on analyser properties, simulations and mechani-

cal construction ideas. This was the first opportunity for groups currently planning these spectrometers to meet in one place. Given the similar nature of these projects it also fostered discussion of some strategic framework and commonality for projects as user instruments, for example in data reduction and analysis.

The workshop was a great success in terms of the instrumentation which was discussed and also the open, cooperative atmosphere that was built. The meeting also led to the close collaboration between the BAMBUS and Multi-FLEXX groups and has resulted in recent tests on a multi-analyser prototype on PANDA at the FRM II in the last cycle.

*J. Lim, A. Schneidewind (JCNS)*

## Workshop McPhase

Garching: November 06-07, 2014



Organised by the MLZ Science Group Quantum Phenomena, a McPhase training workshop was performed at Garching on November 6<sup>th</sup>-7<sup>th</sup>, 2014. 25 MLZ scientists and PhD students took the opportunity to be trained in the use of McPhase.

McPhase is a mean-field Monte-Carlo program to calculate phase diagrams and magnetic properties in localised electron systems:  
[www.mcphase.de](http://www.mcphase.de)



Focusing on practical training, the participants learned how to use the different tools and the principles of the different applications. We also calculated susceptibility, magnetisation, magnetic

structures, CEF, and spin waves on examples taken from actual science. Prospects and constraints of this mean-field based package were actively discussed.

The training was guided by Michael Loewenhaupt (Technische Universität Dresden), Manh Duc Le (Seoul National University), Jens Jensen (Copenhagen University), and Martin Rotter (McPhase consultant), granting us two very efficient days within an open, creative atmosphere, having pleasure to see the results coming up as diagrammes and colour plots on every laptop.

The workshop was accompanied by lectures on November 5<sup>th</sup>, held by Jens Jensen about "Linear Response Theory and the Random Phase Approximation" and Manh Duc Le, about "Spin-Waves and Exchange Interactions in Multiferroic Materials", organised in cooperation with TRR80.

*A. Schneidewind (JCNS)*



Photos by W. Schürmann (TUM).



## Science and industry in dialogue: Innovations in testing technology

VDI Expertenforum at Garching: September 11, 2014

“Non-destructive testing for the mobility and energy of the future” was the 5<sup>th</sup> VDI Expertenforum’s title, held in cooperation with the MLZ in Garching on September 11<sup>th</sup>, 2014. One of the founding members of the VDI Technical Committee on application-oriented and non-destructive testing of materials is Ralph Gilles (FRM II). He took over the local organisation and presentation of the event. With more than 80 participants, this workshop has now earned a place among the developers and testers and attracts many industrial users – by the way all lectures came exclusively from practice.

In his opening speech, Winfried Petry (FRM II) presented some examples of joint projects with industrial customers and took the opportunity to mention the high number of excellently trained young academics. Alexander Hirnet (Varta Storage GmbH) introduced the demands that are placed on the batteries of the future. Together with the group of Ralph Gilles he made numerous measurements with neutrons (diffraction, small-angle scattering and radiography) and presented the results achieved so far. Ingo Manke (Helmholtz-Zentrum Berlin) added some examples of imaging techniques with neutrons, which clearly showed the role of the lithium distribution (batteries) and the distribution of water (fuel cells) for the function.

Also this year, residual stresses of workpieces play an important role at the Expertenforum. According to Wolfgang Zinn (Zentrum für Randschichtanalytik und -technologie) the questions here have especially to do with identifying the correct parameters for testing and then controlling them for quality assurance during series production. This question also worries Thomas Schmidt (German Center for Aerospace, Augsburg). He showed an example of an integrated quality assurance in production using cameras and laser scanning sensors. The process could be automated by the use of robots.

Also Deutsche Bahn focusses on continuous investigation to prevent the two most hazardous areas of damage: wheel failures and shaft fractures caused by cracks. Bernd Rockstock (GMH Prüftechnik GmbH,

Nuremberg) showed some examples of test rigs and mentioned that due to the consequences’ dimension caused by such damage, the responsible persons think about live monitoring while driving.

The Materialprüfungsanstalt of the University of Stuttgart is faced with particularly difficult tasks regarding wind turbines, Sandra Dugan explained in her lecture. Rotor blades have a very complex, heterogeneous and often unknown structure with difficulty to be inspected materials. Consequently, they have a wide range of error types, whose effects are not fully known to make matters worse in many cases. Ultrasound, thermography and local resonance spectroscopy are used, but all testing methods are still at the beginning. The situation is complicated by the fact that matching testing methods had not been elaborated during the development of the rotor blades.

“Where is the development of testing methods going to?” Petry asked the referents in the final discussion. In particular the development of light-based methods was referred

to, because they allow a high test throughput, and are relatively cheap. Almost all participants saw a major problem in the abundance of collected data and their evaluation: In the examiners’ opinion this now often requires more time than the real data collection itself. To rate the relevance of the collected data is in many cases also not yet completely successful. The sophisticated imaging techniques make it more difficult to decide whether the finding is suitable as parameter for error checking or not.

As a last highlight at the end of the Expertenforum, Ralph Gilles offered a guided tour of the FRM II. The participants were very impressed by the huge measurement capabilities and already discussed during the tour possible joint measurements.

*Ch. Kortenbruck (FRM II)*



Photos by W. Schürmann (TUM).

## EEBATT explores decentralised stationary energy storage solutions

The Research Project EEBatt “Distributed stationary battery storage systems for the efficient use of renewable energies and support of grid stability” is a multidisciplinary project funded by Bayerisches Staatsministerium für Wirtschaft und Medien, Energie und Technologie. Combining the strength of 14 chairs and departments of the Technische Universität München, the industry partner VARTA Storage GmbH and the Bayerisches Zentrum für Angewandte Energieforschung e.V. (ZAE Bayern), a multidisciplinary team of researchers works together on a wide range of issues concerning stationary storage of electrical energy. The main goal of the project is to investigate, develop and produce a decentralised energy storage device, which ensures that locally generated electrical power can be consumed locally. Based on the actual and expected results for lithium-ion technologies, EEBatt focusses primarily on Lithium ion batteries chemistries involving either Lithium iron phosphate (LFP) cathodes or carbon (C) anodes or both.

The research project EEBatt pursues in the period from 2014 to 2016 the following objectives:

1. Development of an innovative decentralised stationary energy storage system
2. Increase and secure the system security
3. Optimisation and advancement of the “Battery Management Systems”
4. Increase battery lifetime and cycle stability
5. Cost optimisation, modular and scalable product design
6. Reduction of the production costs
7. Increase the overall efficiency
8. Development of an optimally adapted energy management system
9. Cost-effective and intelligent integration

The MLZ, which participates in the objective ‘Increase battery lifetime and cycle stability’, currently offers five neutron methods for non-destructive characterisation of Li-ion batteries, which will be the main task of the neutron source. Together with VARTA Microbattery GmbH, ex-situ measurements on single components

of batteries as well as in-situ measurements during charging/ discharging of batteries will be performed.

Neutron diffraction provides information about the chemical composition, structure of the phases present in the battery electrodes and associated changes during the electrochemical processes. Techniques like small-angle neutron scattering in transmission and reflection geometry, will deliver specific information about the average size, shape and volume distribution of lateral structures (3 - 300 nm) with high statistical relevance upon ageing as well as during charging/ discharging. The PGAA will be used for the determination of elemental composition and concentration of ions in electrodes and the radiography/tomography will be used to probe inner structures within batteries for dimensions greater than 30  $\mu\text{m}$ .

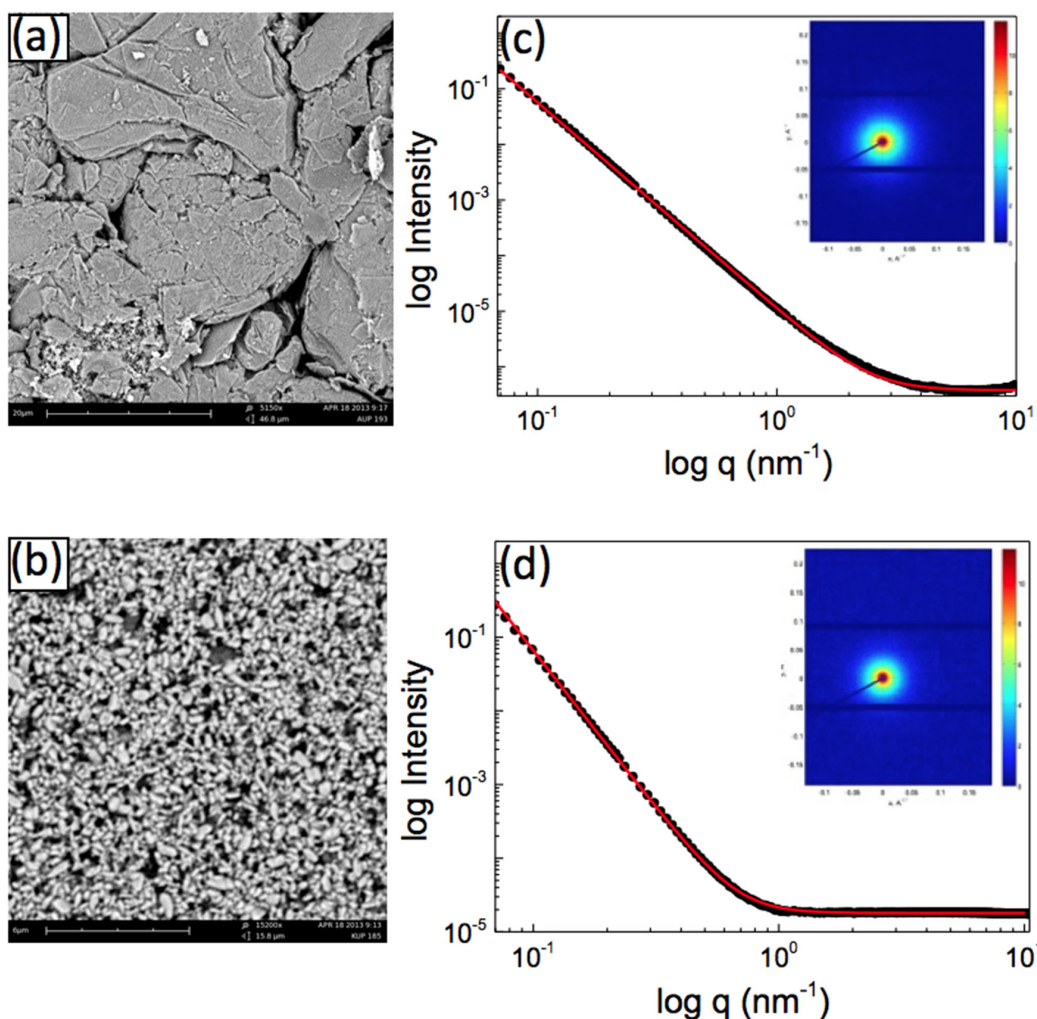

Fig. 1: SEM images of the (a) C and (b) LFP electrodes as well as integrated intensity 1D line cuts and SAXS 2D intensity images for (c) C and (d) LFP electrodes.



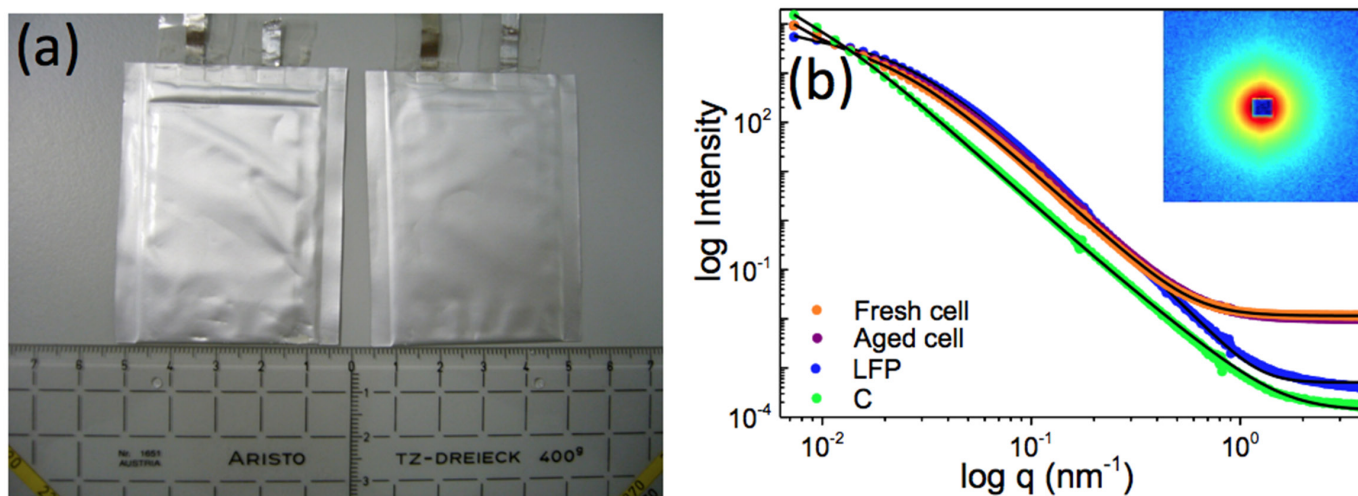

Fig. 2: (a) Pouch cells for measurement using SANS technique. (b) Comparison of integrated intensity 1D line cuts of fresh, aged complete pouch cells (LFP//C) and the single LFP and C electrodes.

pared by VARTA Microbattery GmbH using mainly neutron scattering techniques. Some pre-characterisation is also performed using X-ray scattering techniques to receive complementary results to the neutron scattering measurements. First measurements for the analysis of particle morphology were performed using small-angle X-ray scattering (SAXS) where single battery electrodes such as LFP and C were examined. The SAXS data shown in fig. 1 show no prominent size distribution in the range 3 - 90 nm for either electrode. For both electrodes, model fits show a deviation from Porod behaviour indicating a fractal shape distribution rather than a smooth spherical shape distribution. Their SEM images can also be seen in fig. 1.

Fresh and aged LFP//C pouch cells (shown in fig. 2a) as well as single LFP and C electrodes were also measured at SANS-1 (small angle neutron scattering instrument at MLZ), where a broader size range is ac-

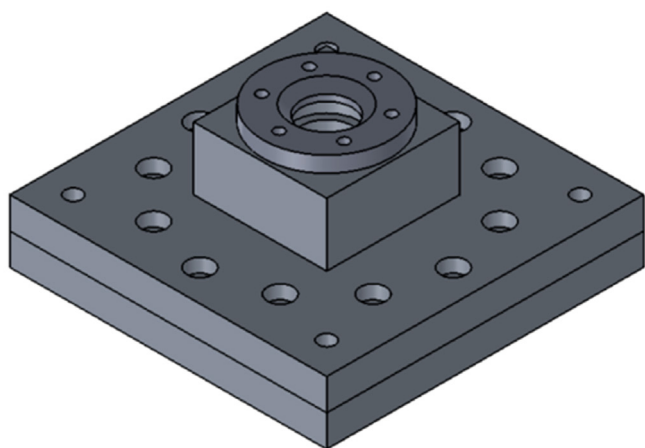

Fig. 3: Sample holder for measurements of single battery components (electrodes) at the REFSANS instrument under a controlled Argon atmosphere.

cessible (1 - 300 nm). 1D integrated intensity line cuts from their SANS 2D intensity images are presented with their model fits using the mass fractal approach in fig. 2b. One representative SANS image from the fresh cell is displayed in the inset. Initial evaluations indicate a slight reduction in the radius of gyration (related to mean particle size averaged over all orientations) from 112 nm to 106 nm on ageing. The scattering contribution is a superposition of particle sizes from both cathode and anode materials which are the major contributors to scattering from the pouch cell.

A sample chamber (fig. 3) is specially designed to place air-sensitive single battery electrodes for in-situ neutron measurements at REFSANS instrument in the reflection mode. The alignment of the sample for grazing incidence is planned with laser light which would be reflected from the glass cover at the top of the chamber. Moreover, pouch cell sandwiched between two silicon slabs will also be measured in this geometry. Due to presence of material characteristic Yoneda peaks in the scattering pattern measured in the reflection geometry, it is possible to assign the particle size to the specific materials in the pouch cell.

For the future, a comparative study with of 18650 cylindrical cells (which vary either in metal oxide based cathode materials, ageing or charging rate) using neutron diffraction and neutron tomography techniques is planned. The aim is to find differences and similarities in the degradation mechanisms of the materials and possible solutions to avoid or suppress the extended ageing of these cathode materials in cells with a graphite anode.

*R. Gilles, N. Paul (FRM II)*

# Bridging the gap between X-rays and neutrons @ STRESS-SPEC

Non-destructive residual stress measurements from the surface into the bulk

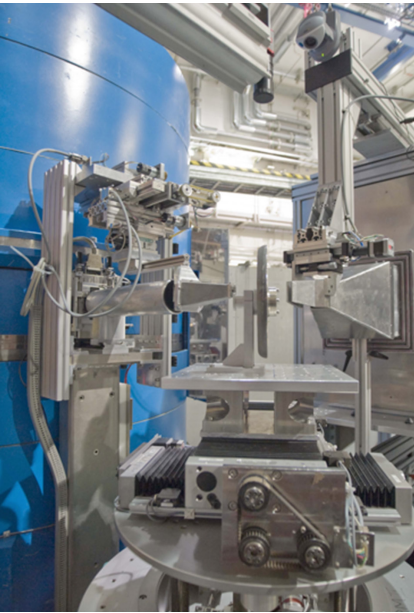

Fig. 1: STRESS-SPEC.

## Spurious strains

Among non-destructive diffractions methods neutron scattering offers the highest potential for determination of the local tri-axial residual stress distribution from the surface into the bulk of a component. With neutrons information depths of several millimetres in steel can usually be covered; for determination of near surface data through surface scanning must be carried out. However, the application of neutron radiation to determine the residual strain/stress gradient from the surface to the bulk is problematic as long as the gauge volume (GV) is not totally immersed in the material. Aberration peak shifts arise due to the fact that the GV being defined by the primary and secondary optics is partially outside the sample. These “virtual” shifts in strain are also called ‘spurious strains’, and arise primarily from the divergence of the incoming neutron beam.

Various experimental approaches – like e.g. repetition of the through surface scan after flipping the sample for 180° – have been proposed to compensate for the surface effect. However, all these experimental techniques have the drawback of being tremendously time consuming and are often simply impractical.

## Minimisation of spurious strains

An alternative is the minimisation of the surface effect by choosing an appropriate instrument configuration compensating for the surface effect in a self-consistent way. Modern neutron diffractometers for strain/ stress analyses are often equipped with horizontally focusing monochromators, which allow tuning the resolution by simply varying the horizontal curvature. This is the method used at STRESS SPEC (fig. 1) to minimise the surface effects experimentally. Through surface scans at a stress free steel sample were carried out for different monochromator radii and different geometries in transmission and reflection mode and the resulting spurious strains were analysed (fig. 2).

The results showed that by setting the appropriate monochromator radius in combination with using a radial collimator in the diffracted beam, the surface effects can be almost entirely suppressed. This way, direct measurements without any type of additional elaborate corrections can be conducted and the method has been already successfully applied to evaluate the stress state in samples after shot peening [1].

## Analytical model

As a further development Monte Carlo (MC) numerical analysis was used as an efficient tool for simulation of the surface effect and optimisation of the STRESS-SPEC instrument configuration [2]. By this means spurious strains can be corrected for measurements carried out using a standard instrument setup, where large spurious strains can be expected. Further on, the optimum instrument configuration for suppressing spurious strains can be predicted a priori using this approach. Measurements on a deep rolled steel sample using the standard setup but corrected for spurious strains were compared with direct measurements (direct in the sense that no compensation measurements or data corrections were carried out) using the instrument setup for ‘a priori’ spurious strain minimization (fig. 3). The data show excellent agreement and emphasise the applicability of the approach.

Moreover in collaboration with J. Saroun (Nuclear Physics Institute, Řež, Czech Republic) a novel analytical model [3] has been developed for the prediction of the surface effect. This model covers a broad variety of instrumental arrangements, including flat mosaic and bent perfect crystal monochromators and narrow slits as well as Soller and radial collimators. The model is capable of accurate quantitative prediction of the surface effect.

The results obtained are encouraging for future routine use of this model for near surface strain/stress analysis on high flux neutron strain scanners like STRESS-SPEC. Experiments at strain scanners of other neutron sources (Salsa@ILL, Engin-X@ISIS) are currently underway or planned to expand and universalise the model.

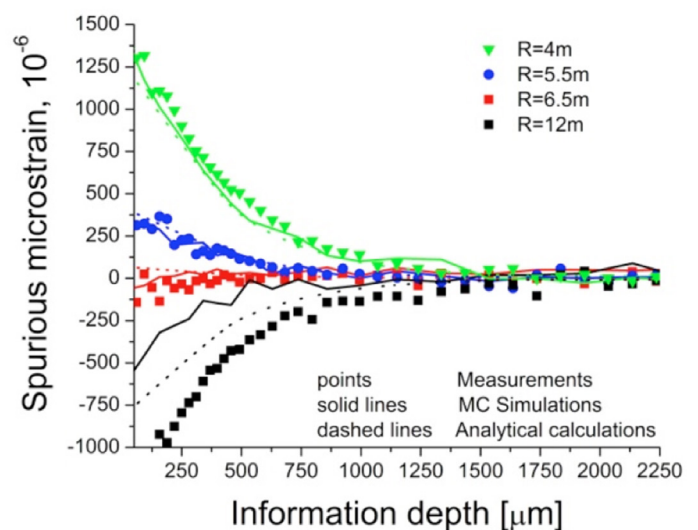

Fig. 2: Comparison of analytical calculations (dashed lines), MC simulations (solid lines) and experimental data (points) of spurious strains for the STRESS-SPEC diffractometer with bent Si(400) monochromator at different radii of curvature, R.



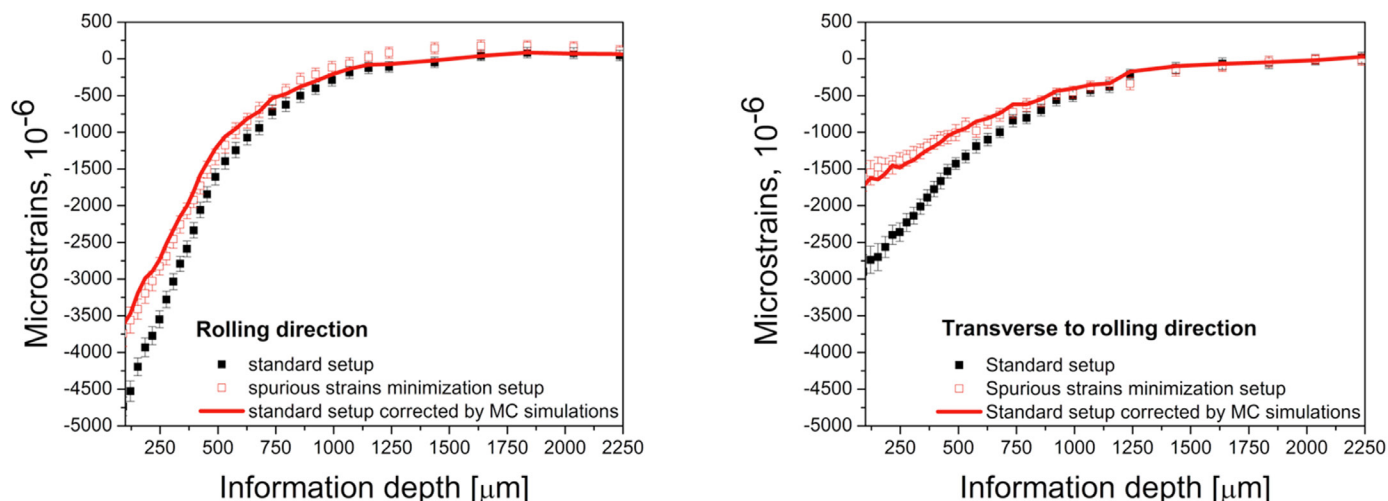

Fig. 3: Depth profiles of microstrains for a deep rolled steel sample. Comparison between experimentally determined microstrains measured using standard setup (full symbols) and setup for spurious strains minimisation (open symbols) and microstrain data measured using standard setup being corrected for surface effect by MC simulation (line).

We are convinced that the approach to model quantitatively the surface spurious strains will enable to bridge the gap between bulk neutron measurements and surface data obtained using X-rays and/ or synchrotron radiation. Using this approach elaborate reference measurements can be stunted. Hence non-destructive strain/ stress measurements from the surface into the bulk of the materials in all mandatory strain directions will be possible by neutron diffraction.

### Applying the model to reality

Based on the instrument development presented here various industrial applications have been successfully realised at STRESS-SPEC. For instance within the scope of a research project between the Institute of Applied Materials (KIT) and FRM II funded by the German Research Foundation (DFG) first analyses for laser hardened steel samples were carried out. Stationary laser surface hardening results in a local martensitic hardened lens with a depth of about 1 mm, which is embedded in ferritic/ bainitic base material.

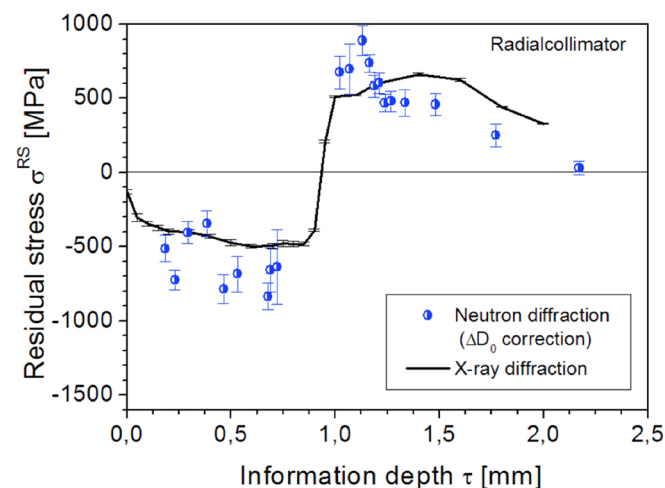

Fig. 4: Residual stress depth distribution for a laser hardened SAE 4140 (German grade 42CrMo4) steel sample. Comparison of neutron through surface scanning results with X-ray data.

The conventional approach for residual stress depth analysis in such a case is using lab X-ray diffraction in combination with electrochemical polishing. However, the local layer removal causes redistributions of the local residual stresses and hence, the original stress profile cannot be provided this way. The analysis must be accompanied by elaborate simulations of the redistribution effect. Non-destructive analysis can overcome this deficiency and here, through surface neutron strain scanning provides a promising alternative.

Fig. 4 shows first results of the residual stress depth profile in the martensitic process zone and in the base material. Neutron data were corrected/ compensated for spurious strain at the very surface and at the interface between martensitic process zone and base metal. The final residual stress data presented in fig. 3 are compared to X-ray data that were determined in the classical way using X-ray residual stress analysis according to the  $\sin^2\Psi$ -method after successive electrochemical layer removal.

The agreement is good and the differences between the X-ray data and the neutron results are inter alia due to local redistributions of residual stresses caused by the local layer removal that must be applied to gain access to the measurement location. Again the latter highlights the potential of using neutron diffraction as a truly non-destructive technique for surface strain determination.

### References

- [1] J.R. Kornmeier, J. Gibmeier and M. Hofmann, Meas. Sci. Technol. 22 (2011) 065705
- [2] J.R. Kornmeier, J. Saroun, J. Gibmeier and M. Hofmann, Mater.Sci. Forum. 768-769 (2014) 52-59
- [3] J. Saroun, J.R. Kornmeier, M. Hofmann, P. Mikula, and M. Vrana, J. Appl. Cryst. 46 (2013) 628-638

*J. Gibmeier (KIT), M. Hofmann (FRM II),  
J. Rebelo-Kornmeier (FRM II),  
J. Saroun (Nuclear Physics Institute)*

## A short review of the work of the 9<sup>th</sup> KFN – and new tasks for the 10<sup>th</sup> KFN!

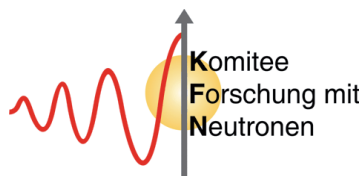

On September 23<sup>rd</sup>, 2014, the constitutional meeting of the 10<sup>th</sup> German committee research with neutrons (KFN) took place in Bonn. At this meeting it was the time to take stock and reflect for a few moments on what the 9<sup>th</sup> KFN has managed within the last election period [1]. The main topic of this time was certainly the general European support and especially the German contribution for the ESS. Both was finally achieved on July 4<sup>th</sup> this year. This is a great success for the user community and marks a new milestone for the European research with neutrons.

Another important event in 2014 that was co-chaired by the 9<sup>th</sup> KFN was the German conference for research with synchrotron radiation, neutrons and ion beams at large scale instruments which took place in Bonn from September 21<sup>st</sup> to 23<sup>rd</sup>. Although the starting date on Sunday morning was clearly not compatible to the family life of the scientists the ambiance of the world conference centre in Bonn (former plenary hall of the federal parliament) and the highly attractive program compensated for this discomfort. The significant importance of neutron research was very visible at this conference by lots of exciting invited and contributed talks and especially by Winfried Petry who could inspire the audience in his evening talk entitled 'Searching for tomorrow's knowledge: discovering the world with neutrons' [2], the plenary talk of Andreas Magerl, and the keynote lecture of Richard Dronskowski. Another highlight of the conference was clearly the award ceremony of the Wolfram-Prandl-Award to Marc Janoschek but also his excellent award lecture in plenary.

Now, I would like to thank all members of the 9<sup>th</sup> KFN for their active engagement and great efforts which significantly contributed to strengthen the German user community. I particularly like to thank Regine von Klitzing and Georg Roth, who both will not be a member of the 10<sup>th</sup> KFN, for their help across all areas of the KFN activities. I warmly welcome the new members of the 10<sup>th</sup> KFN namely Astrid Schneidewind, Wiebke Lohstroh, and Thomas Brückel.

Although some important goals could be reached by the 9<sup>th</sup> KFN, there are still important tasks to be addressed. Two of them are reflected by the implementation of corresponding responsibilities. Astrid Schneidewind will be responsible for 'collaborative research' (Verbundforschung) and Wiebke Lohstroh for 'ESS - participation of German universities'. These new areas of responsibility clearly mark two key sectors for the activity of the 10<sup>th</sup> KFN besides 'instrumentation' (Richard Dronskowski) and 'public relations' (Andreas Schreyer). I am delighted that Thomas Hellweg accepted his election as a deputy chairman of the KFN.

We all are looking forward to the upcoming tasks and new developments such as the construction phase of the new instruments at the ESS where German institutions are already involved in five instrument concepts. Hopefully some more will follow in the next selection round. In spring 2015 the new collaborative research round will be established. The KFN already started an intensive discussion about the strategic focus of this new round and we would highly appreciate any ideas and support from the community. Also the discussion about a European vision for research with neutrons is receiving more and more attention. I am very happy that in this situation Christiane Alba-Simionesco accepted to take the ENSA chair for the next period. I am looking forward to the continuation and strengthening of our successful cooperation with our European colleagues for the benefit of our European infrastructure for research with neutrons.

Now I would like to thank all of the users of neutron research facilities for their support and your engagement for our fascinating wide areas of research. I wish all of you and all other readers of this MLZ newsletter Merry Christmas and a Happy New Year 2015.



Tobias Unruh  
Chairman of the 10<sup>th</sup>  
Komitee Forschung mit  
Neutronen (KFN)  
Tobias.Unruh@fau.de

### References

[1] for more details please refer to the short protocol [www.sni-portal.de/kfn/kfn/Prot-76.php](http://www.sni-portal.de/kfn/kfn/Prot-76.php)

[2] [www.sni-portal.de/Archiv/20140917-suche-wissen-von-morgen-sni-2014-kfn-website.pdf](http://www.sni-portal.de/Archiv/20140917-suche-wissen-von-morgen-sni-2014-kfn-website.pdf)



## Nothing to fear for an engineer...

Building, maintaining, and operating the instruments at the MIZ is an enormous technological challenge. During the construction and building phase, the external groups responsible for the instrumentation projects managed to fulfil these requirements rather independently. Nowadays, the operation and further development of the instruments requires a broad range of technical skills on-site at the MLZ. A particular task is to maintain and improve even further the technical know-how gathered during the construction phase and since then ten years of operation experience. As the groups operating the instruments are quite different in size and organisation, two schemes evolved.

### JCNS instruments

When it became clear that the DIDO reactor, the Jülich neutron source, would be shut down in 2006, seven instruments were transferred to Garching and an outstation of the **Jülich Centre for Neutron Science (JCNS)** was founded here. The technicians located at Garching are organised in a centralised working group. This means that all technicians (at the moment there are 11) work at any JCNS instrument. Their head, Simon Staringer – a mechanical engineer himself – explains that all upcoming tasks dealing with the instruments are distributed within his group. Yes, he concedes, there are colleagues with special skills and therefore mostly working at one special instrument – but in principle the next idle technician is in charge of the job. There is also a tight connection to the sample environment group supporting the setup of the requested equipment for the scheduled experiments. Furthermore some additional help comes still from Jülich: Many technicians helped during the transfer to Garching and they are still specialists whenever big reconstruction projects are on the agenda. This goes especially for the new instruments POWTEX and TOPAS. Both are constructed in Jülich and will be installed in the new Neutron Guide Hall East.

### University and other groups

To overcome the singularity of knowledge at the instruments, a regular meeting of the instrument technicians and engineers was established. The exchange of expertise and the performance of common projects are the two pillars of this newly formed group. In contrast to the JCNS organisation the members of the FRM II group remain associated to their instrument. A former well-established bilateral support on a working basis is extended to a larger number of persons. This is why 13 engineers and technicians started meeting once week conducted by Eugen Caftanat, a new staff member of the infrastructure group. He brings in his working experience as project engineer from the automotive industry. The change management from the working perspective is not at all an easy task, however, the



The JCNS technicians from left to right: T. Kohnke, M. Goedel, J.-P. Innocente, B. Großmann, F. Stoica, S. Staringer, D. Vujevic, H. Kusche, A. Richter, V. Ossovyi, A. Nebel.

profit for example for new staff members to be trained and integrated in the special work conditions at the MLZ and the exchange of know-how will certainly be beneficial for the entire group.

One can certainly not judge on the performance of the different group organisations, both are doing excellent jobs. Both group leaders are looking forward to exchange their experience based on the differently established working traditions.

*E. Caftanat (FRM II), S. Staringer (JCNS)*



The FRM II technicians: D. Bausenwein, W. Hulm, S. Semecky, J. Pfanzelt, N. Jünke, K. Lehmann, K. Braun, J. Huber, R. Schwikowski, S. Vohburger, A. Wilhelm, E. Caftanat (from left to right).



## Both instrument scientists newly arrived at RESEDA!



For the first time, an instrument at the MLZ gets a completely new crew of instrument scientists.

Wolfgang Häußler and Nicolas Martin left during summer/autumn this year and in November, Thorsten Schröder and Christian Franz took over.

I did a doctorate in inorganic solid state chemistry. The topic of my thesis was structure property relationships of telluride based thermoelectric materials. My main analytical methods were electron, X-ray and neutron diffraction as well as electron microscopy. Now I'm looking forward to adding dynamic to the structural informations using neutron resonant spin echo spectroscopy. My research interests are temperature and pressure dependent structural and magnetic phase transitions.

+49 (0)89 289 14760  
thorsten.schroeder@frm2.tum.de

*Thorsten  
Schröder*

I did my PhD at the Physics Department of Technische Universität München focussing on crystal growth and low temperature properties of novel intermetallic magnetic materials.

I am looking forward to working at RESEDA because the combination of high resolution spin echo measurements under depolarising conditions gives me the opportunity to investigate quantum phase transitions in great detail.

+49 (0)89 289 14515  
christian.franz@frm2.tum.de

*Christian  
Franz*

The high-resolution spectrometer gives access to a large time and scattering vector-range for quasi-elastic measurements.

It supports transversal and longitudinal **Neutron Resonance Spin Echo (NRSE)** methods and techniques that enable measurements in strong magnetic fields and under depolarising conditions.

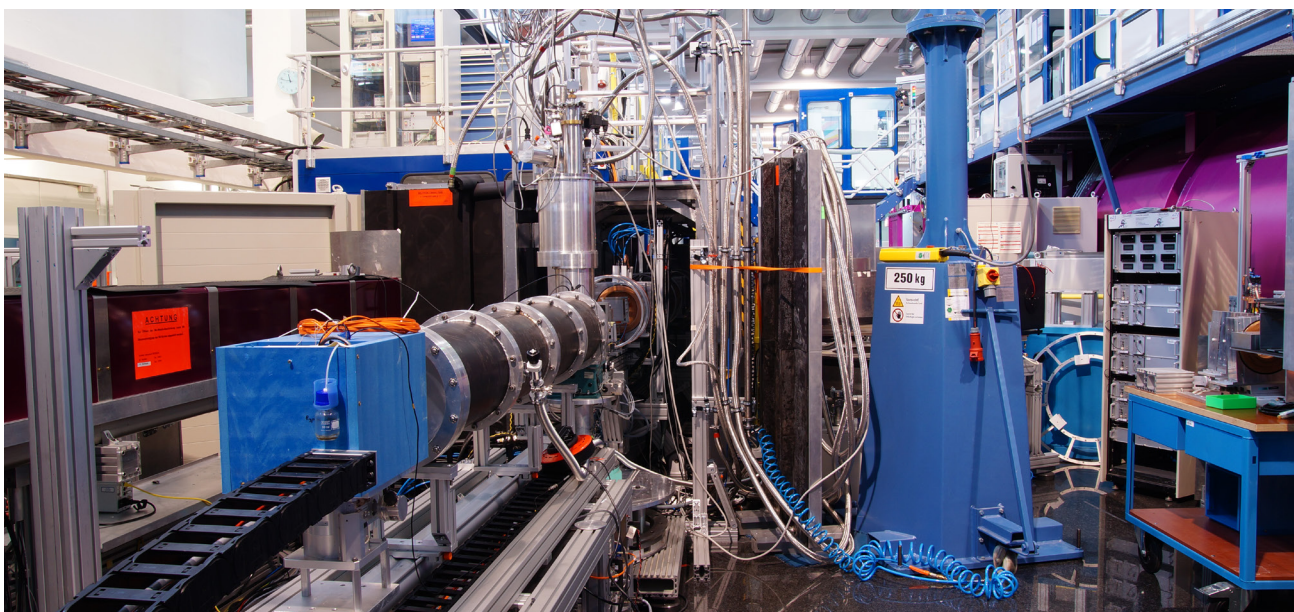

Find the details at [mlz-garching.de/reseda](http://mlz-garching.de/reseda)



Don't forget to register for the MLZ User Meeting 2015!

# Trends in Neutron Science

## MLZ User Meeting 2015

Ismaning – Commundo Tagungshotel, Feb. 23<sup>rd</sup>-24<sup>th</sup>, 2015

### Objective

The MLZ User Meeting 2015 aims on an outlook on the expected evolution in major fields of science, where neutrons significantly contribute. The goal is to create a science roadmap that will guide the development at MLZ for the coming decade. Invited talks will lay the basis for in-depth discussions within the user community.

### Topics

- soft matter and biology
- quantum phenomena and magnetism
- material science
- structure research in chemistry and energy
- neutron methods
- nuclear, particle and astrophysics

### Call for Abstracts

Present your experiments done at the MLZ and submit your poster abstract online!

### Financial Support

MLZ covers accommodation at Commundo Tagungshotel for all external users

### Deadlines

Registration	Jan. 08 <sup>th</sup> , 2015
Abstract submission	Jan. 21 <sup>st</sup> , 2015

### Plenary Talks by

- Winfried Petry (Munich, Germany)
- Peter Boeni (Munich, Germany)
- Hartmut Abele (Vienna, Austria)
- Olwyn Byron (Glasgow, United Kingdom)

### Invited Talks

#### Soft Matter/ Biology

- Leighton Coates (Oak Ridge, USA)
- Tommy Nylander (Lund, Sweden)
- Walter Richtering (Aachen, Germany)
- Peter Schurtenberger (Lund, Sweden)

#### Quantum Phenomena/ Magnetism

- Bernhard Keimer (Stuttgart, Germany)
- Bella Lake (Berlin, Germany)
- Christian Pfeleiderer (Munich, Germany)
- Christian Rüegg (Villigen, Switzerland)
- Kristiaan Temst (Leuven, Belgium)

#### Structural Research in Chemistry and Energy

- Richard Dronskowski (Aachen, Germany)
- Helmut Ehrenberg (Karlsruhe, Germany)
- Werner Paulus (Montpellier, France)

#### Material Science

- Eberhard Lehmann (Villigen, Switzerland)
- Andreas Meyer (Cologne, Germany)
- Andreas Schreyer (Geesthacht, Germany)
- Pavel Strunz (Rež, Czech Republic)

Register, submit, and find  
all information at  
[www.frm2.tum.de/indico/event/user2015](http://www.frm2.tum.de/indico/event/user2015)



## Joint forces: Visitors' Service and User Office merged



First of all there is a new face at the Visitors' Service: Claudia Niiranen (left). She took over from Ulrike Kurz - known by so many users and visitors since she dealt with them nearly since the start of user operation here at Garching.

Did you ever wonder, what the special tasks of the Visitors' Service are? Let's just listen to a typical call the colleagues Claudia Niiranen and Bianca Tonin-Schebesta get there:

*"Hi, we are a group of eight and very interested in a tour of the research neutron source because we*

*are retired physics teachers. Is there any possibility to arrange one?"*

Both they are in charge of the organisation of all guided tours – throughout the whole year for groups as well as for single visitors on the Open Day, 3000 per year in total. Per week, normally three to five tours are possible – it depends on workshops and other special events.

On average, our hypothetical retired physics teachers will have to wait about three months for their tour. They will be welcomed at the reception and accompanied to the entrance building where the radiation protection formalities have to be carried out. After a security check, the tour starts: looking into the reactor pool, visiting the Experimental Hall, inspecting the instruments in the Neutron Guide Hall from the visitors' gallery.

But the Visitors' Service does not only prepare access for those visitors, they also prepare this for the scientific users. They check the applications, book the hotel rooms, and pack the blue folders each user is provided with at the reception. This is the connecting link between the Visitors' Service and the User Office – and it is the reason, why we are merged officially in late summer. We are really happy to play in one team now and welcome Claudia warmly!

## There is no end in sight: The User Office Blog continues

On February 14<sup>th</sup> – Valentine's Day by the way...– we published our first blog article on the User Office's web pages. In the night of February 9<sup>th</sup>, the last neutrons had been delivered to the users' experiments before the long maintenance break started. Even for our colleagues at the site it was a mystery what a User Office could do without any users and during the first week we were asked why we didn't go on holiday for the months of the break. With our blog, we wanted to answer this question and show what we did instead and thus the readers could take a look behind the scenes always on Fridays.

We wrote thirty articles during the break, dealing with ducks, frogs, and containers as well as ongoing construction work, the summer festival, preparations for conference booths, the proposal deadline, and so much more. It was not

always easy to find a topic but it was fun. Colleagues started to contribute with ideas or pictures they took and were always cooperative when we need some models – we avail us of the opportunity to express our thanks to each of them!

Because of the positive feedback, we discussed about the blog's planned end when the reactor was restarted. And the result we published:

*"The maintenance break ended on August 22<sup>nd</sup>, 2014. In the mean time, blog writing became a lot of fun and therefore we decided to carry on. And this is why this blog still exists!"*



Our favourite: On August 8<sup>th</sup>, a grass snake could be saved.

Never read but curious? Just have a look, [Always on Fridays...](#)



Don't forget to submit your proposal!

## Next Proposal Deadline: January 16<sup>th</sup>, 2015

### Read the Call for Proposals

- at [mlz-garching.de/user-office](http://mlz-garching.de/user-office)
- or scan the qr-code!

### Submit your proposal at

- [fzj.frm2.tum.de](http://fzj.frm2.tum.de)
- [user.frm2.tum.de](http://user.frm2.tum.de)

### Financial Support

European Users can receive a financial support for their travel, accommodation, and subsistence costs by the NMI3 programme.

Users from German universities are also invited to apply for financial support granted by the collaboration partners.



© A. Heddergott / TUM



© A. Steffen / JCMS



© A. Steffen / JCMS



© W. Schürmann / TUM

## Rapid Access Deadline: February 25<sup>th</sup>, 2015

### Find all information

- at [mlz-garching.de/englisch/user-office/getting-beam-time.html](http://mlz-garching.de/englisch/user-office/getting-beam-time.html)
- or scan the qr-code!



### Submit your proposal at

- [fzj.frm2.tum.de](http://fzj.frm2.tum.de)
- [user.frm2.tum.de](http://user.frm2.tum.de)

## Upcoming

### February 23-March 06

46<sup>th</sup> IFF Spring School  
(Jülich, Germany)  
[www.iff-springschool.de](http://www.iff-springschool.de)

### February 23-24

MLZ User Meeting: Trends in Neutron Science  
(Ismaning, Germany)  
[www.frm2.tum.de/indico/event/user2015](http://www.frm2.tum.de/indico/event/user2015)

### March 15-20

DPG Spring Meeting  
(Berlin, Germany)  
[berlin15.dpg-tagungen.de/index.html?lang=en&](http://berlin15.dpg-tagungen.de/index.html?lang=en&)

*Visit our booth there!*

### August 30-September 04

ECNS 2015: VI. European Conference on Neutron Scattering  
(Zaragoza, Spain)  
[ecns2015.unizar.es](http://ecns2015.unizar.es)

*Visit our booth there!*

### September 13-17

DyProSo 2015: 35<sup>th</sup> Symposium on Dynamical Properties of Solids  
(Freising, Germany)  
[mlz-garching.de](http://mlz-garching.de) (registration starts in February 2015)

## Reactor Cycles 2015

No.	Start	Stop
36b	13.01.2015	12.02.2015
37	10.03.2015	08.05.2015



*Merry  
Christmas  
and a happy  
New Year!*

## Imprint

### Editors

Rainer Bruchhaus  
Flavio Carsughi  
Connie Hesse  
Christine Kortenbruck  
Ina Lommatzsch  
Jürgen Neuhaus  
Andrea Voit

### Layout and Typesetting

Ramona Bucher  
Ina Lommatzsch

### Picture Credits

Front cover above: Wenzel Schürmann/ TUM  
Front cover below and back cover: HENN GmbH  
If not indicated: By editors, authors and/ or FRM II/ TUM

### Contact

Forschungs-Neutronenquelle  
Heinz Maier-Leibnitz (FRM II)  
User Office  
Lichtenbergstraße 1  
D-85747 Garching  
Phone: +49.(0)89.289.10794  
10703  
11751  
Fax: +49.(0)89.289.10799  
e-mail: [useroffice@mlz-garching.de](mailto:useroffice@mlz-garching.de)  
[www.mlz-garching.de](http://www.mlz-garching.de)





The Earth is a sphere....

Photo by P. Baur/ FRM II



