



FRM II news

N° 5

www.frm2.tum.de



Just before Christmas

To support the scientific use of neutrons at our facility, the Federal Republic and the Free State of Bavaria signed an agreement which establishes a collaboration between the Helmholtz Centres at Jülich, Geesthacht, Berlin and TUM, lasting for a first period of 10 years on December 17th. The scientific exploration of the FRM II will be shared between TUM and the Helmholtz Centres, with FZJ as the leading partner among the Helmholtz Centres. The nuclear operation of the FRM II remains completely in the hands of TUM. The annual budget spent by the partners at Garching will increase by about 20 Mio€ per year. After the shut down of the reactors at Jülich and Geesthacht, a strong focus on neutron research in Germany has been established in Garching at the FRM II. This important milestone opens up the way for a bright scientific future of our facility.

At about the same time a further important step to the future of neutron scattering in Germany and Europe was made. Funded by the BMBF a HGF-TUM initiative for the design update phase of the European Spallation Source was launched on December 1st 2010. Topics include target and accelerator developments as well as new concepts of instrumentation and components. The funding covers a period of three years with a total budget of 21 Mio€ including 6 Mio€ of own funding by the partners.

Last but not least, an important R & D agreement between the BMBF and the Bavarian Ministry for Science, Research and Art has arrived late in October this year. Despite the enormous international effort developing a high density fuel, today it is technical not possible to operate high performance research reactors like the FRM II with lower enriched fuel. Therefore the funding for this development has been prolonged. According to today's world wide knowledge, the availability of high density fuels can be expected around the mid of the coming decade. Hence from today's perspective 2018 seems to be a realistic estimate for the conversion of the FRM II fuel element to lower enrichment.

Winfried Petry, *Scientific Director*

Deadline Proposal Round May 6th, 2011



user.frm2.tum.de



fzj.frm2.tum.de

Instrumentation

REFSANS	2
BioDiff	3
MARIA	4
Radioisotopes for Europe.....	6
SPHERES	7
POLI	8
KWS-1 and KWS-2	10
TRISP	12
New instrument for x-ray tomographies	14

Events

NeT at the FRM II	15
Workshop on sample environment.....	15
JCNS workshop 2010	16
JCNS LabCourse 2010	17
Colloquium in honour of Tasso Springer	17
3 rd FRM II user meeting	18
HOKO2010	18
Political visitors	19

Science & Projects

Collaboration agreement signed	20
Design-update-phase of the ESS	21
Industrial applications	22
Neutron induced disruption.....	24
From the bulk to the atomic scale	26
PERC	28

Inside

Software and hardware at its best	29
Newly arrived	30
FRM II's Blue Book	30

Outside

KFN	31
-----------	----

User Office

User development	32
Call for proposals	32
FRM II user survey	33
Upcoming	34

Update of REFSANS' main chopper

Last May, the horizontal reflectometer REFSANS upgraded its chopper. The concept of a van Well chopper had been kept but, in order to improve the reliability and to increase the maximum speed up to 6000 rpm, a new system was designed in collaboration with the companies EADS/ASTRIUM (for the mechanical parts and the disks) and MACCON (for the control electronics).

The original van Well setup consists of a double disk chopper. The first disk or master (MC) delivers a long white beam pulse to the second disk or slave (SC1). The role of SC1 is to limit the spectrum to a given wavelength range. For each neutron the time of flight is then measured at the detector in order to determine the corresponding wavelength. The wavelength resolution of this setup is normally chosen at construction time by tuning the distance from MC to SC1 (as well as the angular opening of the transparent window, see fig.1). At REFSANS, this setup was further improved by replacing each disk by a pair of two disks with a 120° transparent sector. Adjusting the phase between two components of a pair enables to arbitrarily define a window between 0° and 120°. Moreover, the SC1 was mounted



Figure 2: One of the master disks. The black absorbing material defines several windows to enable different chopping schemes.



Figure 1: The chopper chamber of REFSANS during the test phase. The master disks are inserted in the guide while the slave disks are on a parking position outside of the beam path (view from reactor to sample).

on a translation table and can be moved to any out of four gaps in the neutron guide. For a given window/distance configuration, the relative wavelength resolution of the chopper is basically constant and given by the ratio of the chopper length to the detector distance. As a result REFSANS has access to resolutions in the range of 0.1-10 %. Moreover, the transmission of such a setup increases linearly with wavelength so that it is possible to make use of the neutrons over a rather broad range of wavelength (typically 2 to 20 Å). As seen in fig. 2, several transparent windows are available additionally to the 120° main sector. These narrow slits can be used in chopping schemes where each disk fully defines a window. This is for instance useful if one desires to operate in counter-rotating disk modes to increase the reflective pulsing speed. This multi-window design gives REFSANS a great flexibility and allows it to be used in TOF mode (the main operation mode) or as a monochromatic instrument if needed. The 800 mm diameter disks are machined from aluminum and covered on both faces with 10 B in order to achieve a transmission below 10⁻¹⁰, a figure necessary to enable measurements of very low reflectivities. The symmetric coating ensures a better mechanical stability at all speeds.

The increased accessible rotation speed now offers the possibility to better tune the wavelength range used to access a given Q range while still making optimal use of the source spectrum. For instance, if the maximum measured wavelength can be kept around the peak of the source spectrum, e.g 6 Å, it is then possible to increase the flux by a factor of 3 with respect to what was used with the former chopper setup.

BioDiff: The new single crystal diffractometer for proteins

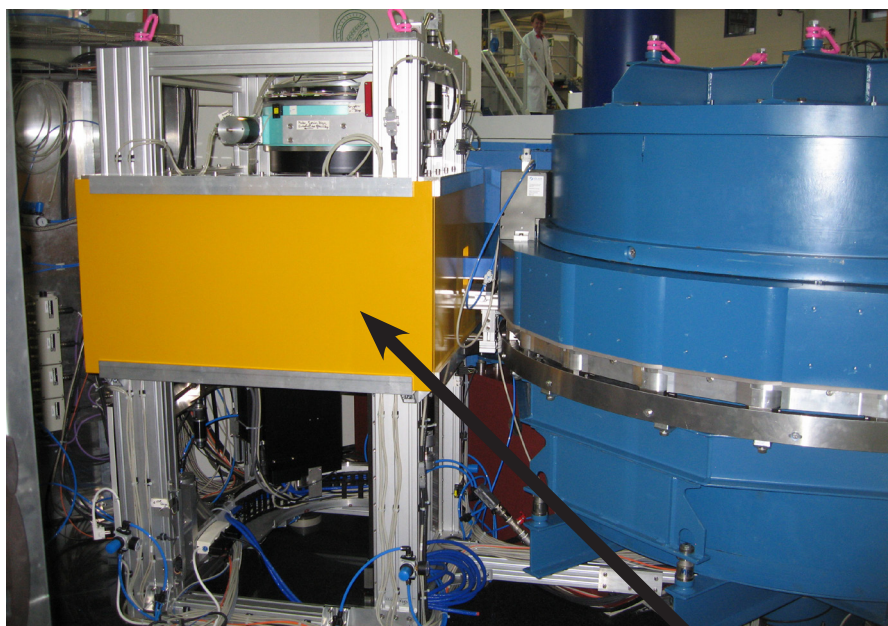

Figure 1: Sideview of BIODIFF with the monochromator housing (blue) and detector unit with shielding (yellow).

The new monochromatic single crystal diffractometer BIODIFF is designed for the data collection from crystals with large unit cells. The main field of application is the structure analysis of proteins, especially the determination of hydrogen atom positions. Typical questions to be investigated are enzymatic mechanisms, ligand binding mediated by hydrogen bonds, the hydration shell of proteins, and the analysis of H/D-exchange patterns. BIODIFF is a joint project of the Forschungszentrum Jülich (FZJ/JCNS) and the Forschungs-Neutronenquelle Heinz Maier-Leibnitz (FRM II). The instrument is located in the neutron guide hall west at the beam port NL1 in front of the reflectometer N-REX⁺ and the instrument for particle physics with cold neutrons MEPHISTO (fig. 1).

The instrument utilizes the lower part (25 mm) of the neutron guide NL1. By using a highly orientated pyrolytic graphite monochromator (PG002) the wavelength can be varied between 2.4 and 5.6 Å, thereby enabling optimization of the number of measurable reflections and the spatial resolution. Higher order wavelength contaminations are removed by a neutron

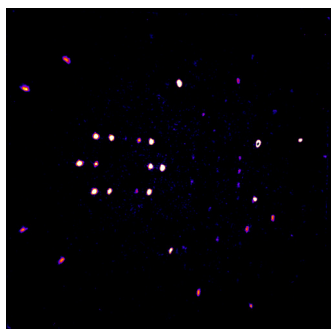

Figure 3: Diffraction pattern of a protein crystal (myoglobin) collected with the CCD camera of BIODIFF.

velocity selector within the monochromator housing. The main detector of the instrument consists of a cylindrical neutron image plate detector with a diameter of 400 mm and a cylinder height of 450 mm. It thus covers a large solid angle of approximately 2π . In addition the instrument is equipped with an Li/ZnS scintillator CCD camera providing an active area of 200 mm x 200 mm. The CCD camera can rotate around the sample in a 2θ range between 0° and 113° . The switching between the detectors is controlled by the data collection software (fig. 2). BIODIFF is equipped with a standard Oxford Cryostream 700 plus which allows measurements in the temperature regime from 90 K up to 500 K.

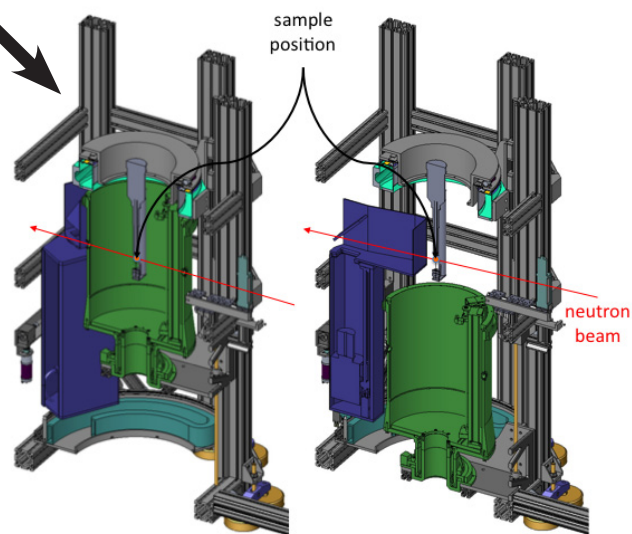

Figure 2: Arrangement of the cylindrical neutron image plate detector (green) and the CCD detector (blue). Left side: neutron image plate in active position. Right side: CCD camera in active position, neutron image plate in park position.

The main advantage of this instrument is the possibility to adapt the wavelength to the size of the unit cell of the sample crystal while operating with a clean monochromatic beam that keeps the background level low. The first neutron beam hit a protein crystal at BIODIFF in October. At this time the CCD camera was already mounted and successfully tested with neutrons (fig. 3). In December 2010, the image plate detector was installed. The commissioning phase of the instrument will start with the first reactor cycle in 2011. After this BIODIFF is available for friendly users.

MARIA – the new high flux JCNS reflectometer

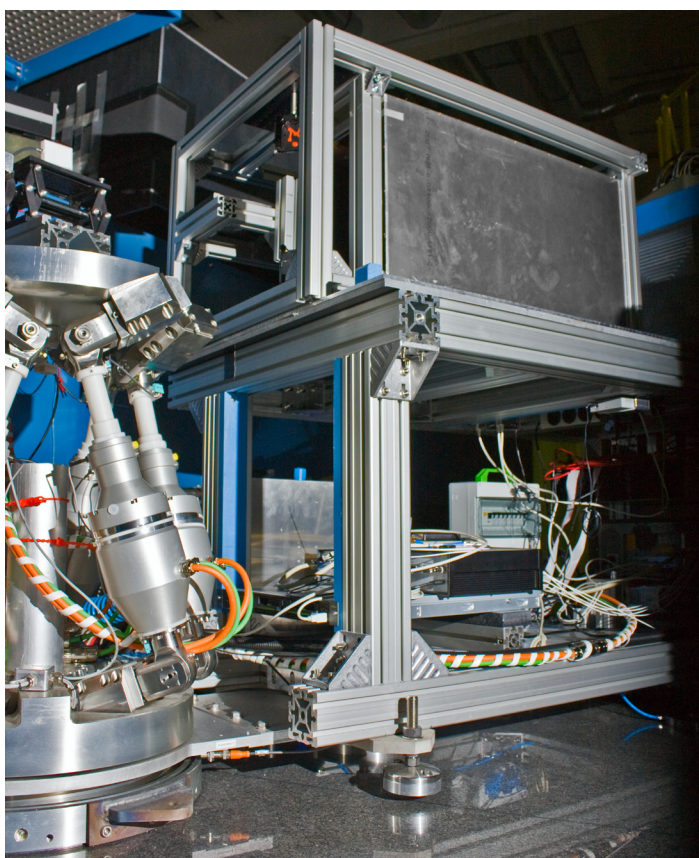

Figure 1: The sample position of MARIA with hexapod, ^3He -SEOP-analyzer and detector.

The new high flux polarized neutron reflectometer MARIA (**MA**gnetism **R**eflectometer with high **I**ncident **A**ngle) of the JCNS is optimized for the study of magnetic nanostructures, serving the rapidly growing field of spintronics or magnetoelectronics, i.e. information storage, transport and processing using the spin of the electrons. Therefore MARIA is optimized for layer thicknesses between 3 and 300 Å, lateral structures of nm to μm sizes and sample sizes of 10 x 10 mm². Beside the reflectometer mode with good resolution in the horizontal scattering plane, MARIA is able to measure in the GISANS mode with additional resolution in the vertical direction. The latter mode allows to measure lateral structures down to the nm scale.

To optimize the intensity of the neutron beam at the sample position and the measurement strategy we use a 10 % velocity selector to monochromize the neutrons. Behind the selector a Fermi-chopper (will be installed next year) allows to reduce the wavelength spread to 1 % and 3 % if desired. In the polarization unit a double reflection polarizing or non-polarizing guide for maximum intensity can be selected by the user. With the resonance spin flipper it is possible to change the polarization of the incoming neutron beam. Already in the

polarization chamber the vertical elliptical focusing starts and ends at the last slit of the collimation, 50 cm in front of the sample position. The collimation allows to set the angular resolution of the incident neutron beam in the horizontal plane. While in the reflectometer mode the vertically focusing ellipse is increasing the intensity at the sample position drastically, in the GISANS mode a set of absorbers prevent the focusing of the neutron beam and conserve the angular resolution. Such combination of the two modes without compromising the intensity or resolution of any of them is a unique feature and has never before been realized. These optical devices and their influence on each other were optimized by simulations with the VITESS suite as well as with specialized programs for the detailed understanding of selector, Fermi-chopper and elliptical focusing properties.

Unique features of MARIA include

- vertical focusing with an elliptic guide from 170 mm down to 10 mm at the sample position,
- switch between reflectometer and GISANS mode within seconds,
- polarization analysis over a large 2d position sensitive detector as standard,
- selectable wavelength spread of 10, 3 and 1 %
- flexible sample table using a hexapod for magnetic field and low temperature sample environment,
- provision for kinetic studies by means of time resolution down to the s range,
- in-situ sample preparation facilities.

Together with a 400 x 400 mm² position sensitive detector and a time-stable ^3He polarization analyzer

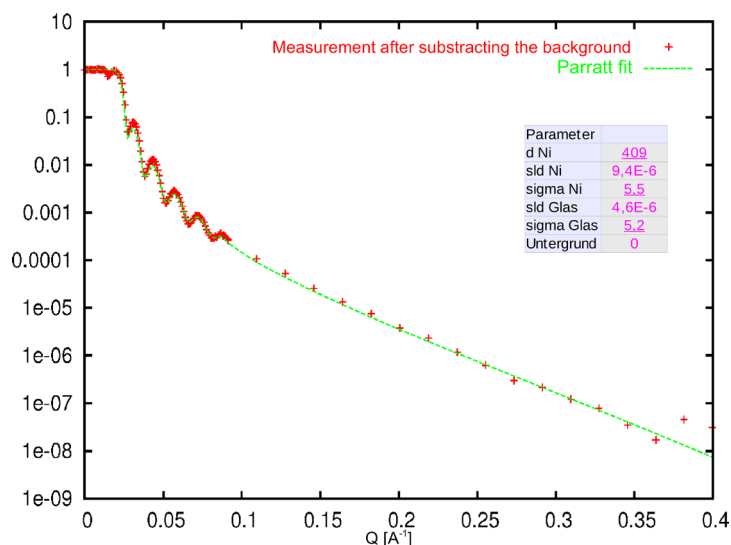

Figure 2: Reflectivity measurement with 6 Å in 4.5 hours of a Ni-mirror with 400 Å layer thickness. The refined parameters are given in the inset (only underlined parameters were refined).

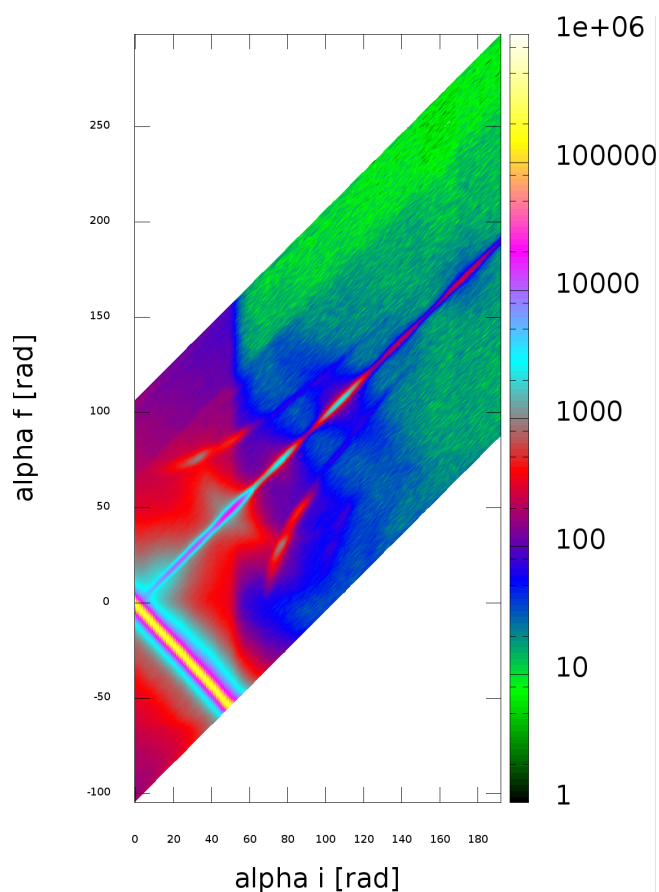

Figure 3: Offspecular scattering of a lateral structured multilayer measured with 24 Å in 9 hours. The multilayer consists of $[(\text{Fe } 15\text{nm}/ \text{Cr } 1,1\text{nm})_{10} (\text{Fe } 15\text{nm})]$ and the top iron layer is structured by a $1\mu\text{m}$ period. (N. Ziegenhagen et al. Physica B 335, 50 (2003)).

based on Spin-Exchange Optical Pumping (SEOP) (E. Babcock et al., Nuclear instruments and Methods in Physics Research A 625, 43-46 (2011)), the instrument is dedicated to investigate specular reflectivity and off-specular scattering from magnetic layered structures down to the monolayer regime.

Direct measurements 120 mm behind the end of the elliptically focussing collimation section of MARIA show a polarized neutron flux of about $0.5 \cdot 10^8 \text{ n/cm}^2/\text{s}$ and an unpolarized neutron flux of about $1.25 \cdot 10^8 \text{ n/cm}^2/\text{s}$ at 4.5 Å with a horizontal divergence of 6 mrad. This makes MARIA one of the most powerful neutron reflectometers in the world.

As a short and incomplete list of the possibilities at MARIA a few examples were chosen from the first measurements done this year.

The first example is a reflectivity curve of a Ni mirror measured at 6 Å. The data was background corrected before it was fitted by Parratt32. The refined

parameters in this fit are the thickness of the Ni layer, the roughness of this layer and the scattering length density of the glass substrate (see fig. 2). All fitted parameters are in good agreement with former measurements of this mirror at TREFF.

Figure 3 shows a measurement of the off specular scattering of a lateral structured sample. The sample consists of an iron/chromium multilayer $[(\text{Fe } 15\text{nm}/ \text{Cr } 1,1\text{nm})_{10} (\text{Fe } 15\text{nm})]$ with the last layer of iron structured by e-beam lithography with a $1\mu\text{m}$ period. Please note the first and second order intensity in the plot.

The third example shown in figure 4 illustrates the capability of MARIA to switch in seconds between the reflectometer mode with a vertically focussing beam on the sample and the GISANS/SANS mode with a pin hole geometry.

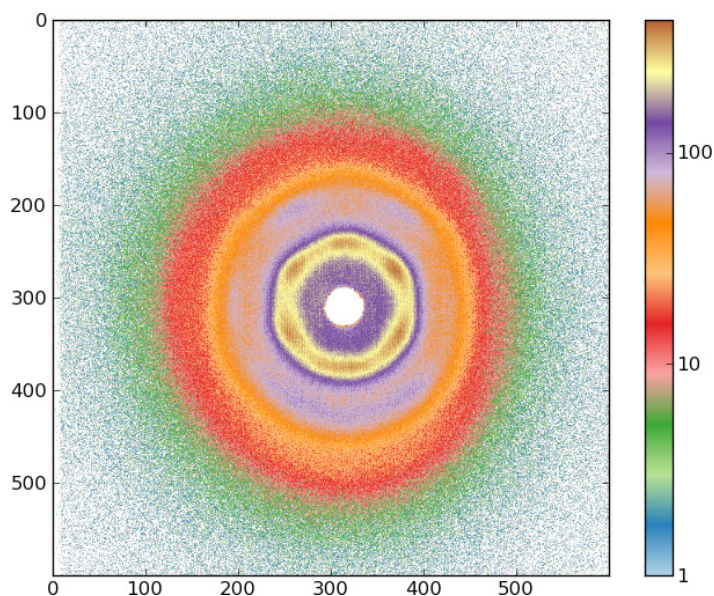

Figure 4: SANS measurement with 20 Å in 2 hours of iron in an aluminium membrane with hexagonal structure and a pore distance of 70nm. (Sample by V. Hähnel, Leibniz Institute for Solid State and Materials Research Dresden. Cf. Masuda and Fukuda, Science 268, 1466 (1995)).

In this year' last cycle, the ^3He SEOP polarization analysis was installed and proved the enormous possibilities of this technique during a standard GISANS measurement with full sample environment. We used a ^3He -cell with 9 cm of diameter as an analyzer and were able to achieve a constant analyzer efficiency of 94 % at 4.5 Å out of the box. This performance has been achieved with a closed cycle cryostat at 10 K and an electromagnet running at 1.1 T.

Radioisotopes for Europe

The new facility for the production of ^{99}Mo is being built

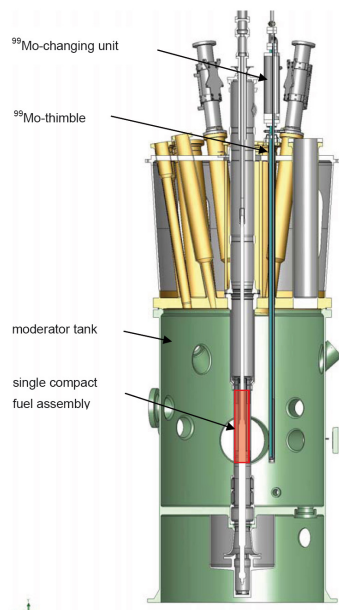

Figure 1: Sketch of the moderator tank at the FRM II with ^{99}Mo production facility.

The radioisotope technetium-99m ($^{99\text{m}}\text{Tc}$) is by far the most widely used isotope in nuclear-medicine. It emits gamma radiation with a low energy of 140 keV and exhibits a short half life of 6 h. These features predestine it for diagnostic imaging of various organs. Throughout the world, more than 35 million patients are diagnosed and treated per year with radioisotopes; out of those 70 % with $^{99\text{m}}\text{Tc}$.

The most common way for the production of $^{99\text{m}}\text{Tc}$ is based on the irradiation of enriched uranium in a neutron source which

results in the generation of molybdenum-99 (^{99}Mo), the mother isotope of $^{99\text{m}}\text{Tc}$. ^{99}Mo is a rather short-lived isotope with a half life of 66 h which makes any stockpiling of $^{99}\text{Mo}/^{99\text{m}}\text{Tc}$ impossible.

The five major neutron sources worldwide producing ^{99}Mo are between 43 and 53 years old and will be decommissioned from 2015 until 2025. Because of maintenance works, the two most powerful sources in the Netherlands and in Canada have been repeatedly out of order and thus causing a shortfall crisis of $^{99\text{m}}\text{Tc}$. The FRM II has started to build a facility for the production of ^{99}Mo .

A feasibility study for a possible irradiation facility at the

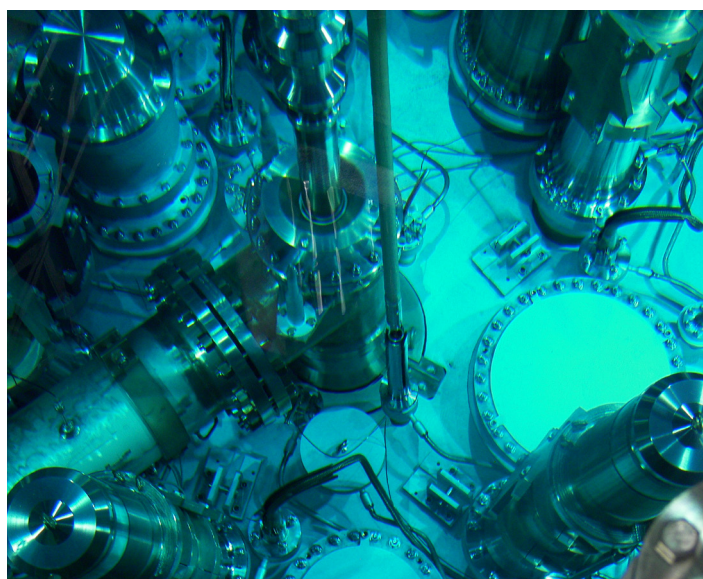

Figure 2: Position of the ^{99}Mo facility in the reactor pool.

FRM II had been finished in 2009 and approved the technical as well as the logistical realization up to the year 2014. The new irradiation position will be able to produce 17 kCi of ^{99}Mo activity per week, which corresponds to approximately 50 % of the European needs. It will supply enough for 5 million treatments and diagnostic examinations with $^{99\text{m}}\text{Tc}$ per year. The FRM II will provide the irradiated targets, which will be transported to a processing facility to enable their use by doctors in devices known as technetium generators.

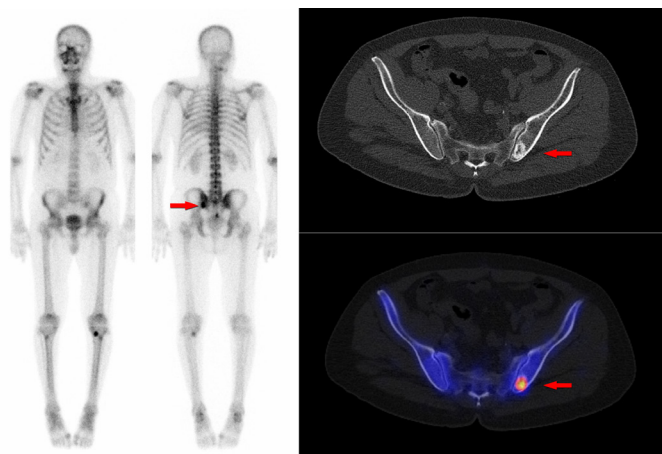

Figure 3: Scintigraphy of a whole body (left) and a 2-dimensional section to identify and localize a tumour with the use of $^{99\text{m}}\text{Tc}$ (right).

The FRM II has already started the realization of the facility. In January, an existing and yet unused thimble (fig. 2) in the reactor tank will be extended and changed in shape. The change of the thimble is possible due to the other maintenance works associated to the exchange of the beam tube SR11 for the refurbishment of the positron source.

Preparations for this thimble have lasted since October 2009. It took one year to finalize paperwork: more than 100 pages of specifications for this new tube, several quality inspections by the Technical Inspection Authority (TÜV), and the approval by the authorities. Further tasks of the engineers include the upgrade of both a goods lift and the crane in the truck airlock for the shipping of the products as well as the development of a storage facility for the targets prior to their irradiation.

The total costs of the installations are calculated to 5.4 Mio€. Financial support is provided by the Bavarian government, industrial partners and the federal government. It is foreseen that the ^{99}Mo production will go into commissioning phase in 2013 and become operational in 2014.

Christian Müller, FRM II

SPHERES gains 50 % in flux and SNR by argon filling

The backscattering spectrometer SPHERES, in continuous operation since autumn 2007, keeps improving. The latest enhancement is quite a big leap: a 50 % flux gain achieved by filling the entire spectrometer housing with argon.

After leaving the guide NL6, neutrons have to travel more than 8 m within SPHERES before they reach a detector: 2 m from the deflector crystals in the phase-space-transform chopper to the monochromator and back, another 2 m from the sample to the analyzer spheres and back, plus some 10 cm of connecting paths. To minimize γ -radiation and neutron background, most of the primary flight path between chopper and monochromator is enclosed in a vacuum chamber. The remaining flight paths have been in air until now.

For neutrons of 6.27 \AA , scattering and absorption in air cause about 8 % loss per metre, depending somewhat on temperature and relative humidity with inelastic effects neglected. This means the unevacuated flight paths of altogether about 4.5 m cost us approximately 30 % of flux. Therefore it had been foreseen from the outset to fill the entire spectrometer housing with argon. By 2010, the instrument had become so stable that we could seriously envisage running it for weeks and months without opening the housing.

Safely holding 56 m^3 of suffocating gas while compensating for fluctuations of the outer air pressure

proved a nontrivial engineering task. After helpful discussions with A. Kastenmüller, R. Lorenz, B. Pollum, and B. Wierczinski of the FRM II, the Jülich engineers A. Budwig and H. Kämmerling worked out a pneumatics and control concept that ensures safety in all phases of operation.

Everything was ready by September 2010, and the first test was performed during the last four weeks of reactor operation before the long shutdown. Less than 10 h of flooding were necessary to bring the oxygen content below 2 %. A scattering experiment on a standard sample gave a flux gain of about 55 %, which is even more than expected from the above rough estimations. The second good news is: the noise level didn't change noticeably, so the signal-to-noise ratio, arguably the most important figure of merit of a backscattering spectrometer, is also up by about 50 %. For a standard plastic scatterer we found a ratio of better than 1700:1 in the six best large-angle detectors (see fig. 1). This qualifies SPHERES as the most sensitive backscattering instrument in the world.

Right now we are working on final adjustments to allow argon filling on a routine basis. Then it will be at the discretion of our users whether they employ the flux gain for shorter experiments, for more spectra per experiment, or for better statistics.

Joachim Wuttke, JCNS

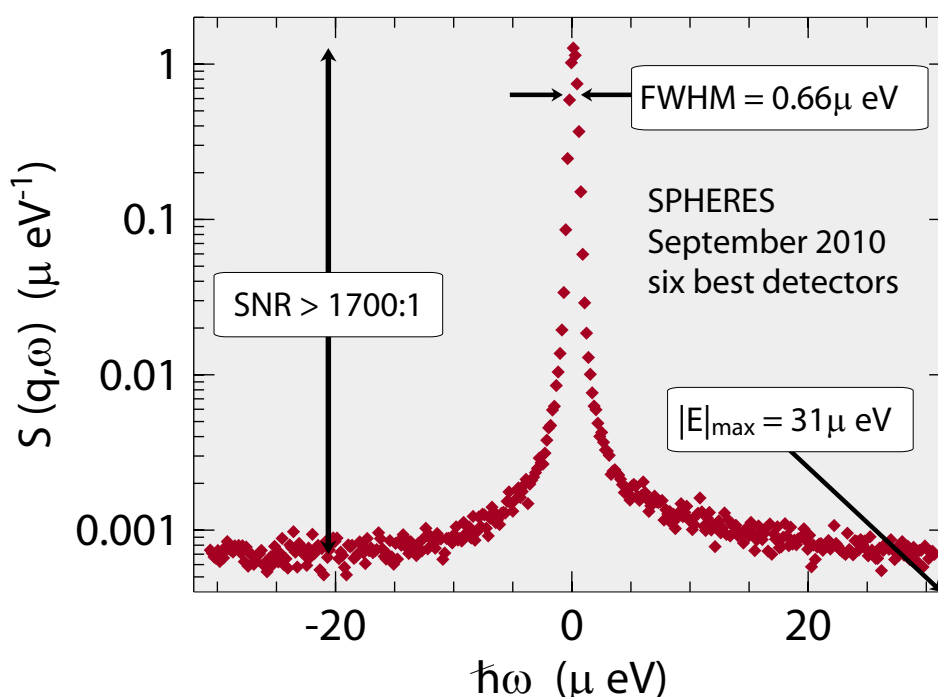

Figure 1: First tests at the argon filled SPHERES.

POLI: the polarization investigator



Figure 1: POLI-HEiDi on beam-port SR 9b during the SNP experiment in April 2010.

The polarization of the neutron beam can be described in the terms of a classical vector and can be manipulated in the frame of the instrument coordinate system. Two different approaches are generally used for elastic scattering with polarized neutrons. The first one uses the measurement of the polarization dependent cross-section of the elastic scattering. Usually scattered intensities for two anti-parallel polarizations of the incoming beam are registered and their ratio is calculated (so called flipping-ratio method).

The flipping-ratio method, also known as polarized neutron diffraction (PND), is a well established technique and particularly well suited to measure spin or magnetization densities around the atomic nuclei and magnetic form factors. The method applies to ferromagnets or fer-

rimagnets, but also to paramagnets or antiferromagnets when a ferromagnetic component is induced by an applied magnetic field. This method is mostly limited to centro-symmetrical crystal structures.

The second method is to observe the changes in the polarization vector of the scattered beam (so called polarization analysis or polarimetry). In 3D polarization analysis or spherical neutron polarimetry (SNP) all components of the scattered polarization vector are measured in turn for three different directions of the incoming polarization vector. Determining the relationship between directions of incident and scattered polarizations gives access to 16 independent correlation functions involved in most general nuclear and magnetic scattering processes. Generally, this leads to the determination of the direction of magnetic interaction vectors of magnetic structures.

For those structures, in which nuclear and magnetic reflections coincide in reciprocal space, SNP leads to the determination of the amplitude of the magnetic interaction vectors, and hence to the magnetization distribution. Magnetic domains which usually occur in the magnetically ordered materials play an important role in their macroscopic properties. If the different parts of the crystal have different directions of the magnetic moment this will lead to depolarization of the scattered neutron beam. 3D depolarization analysis provides directional information of the static domain structure but also dynamical information on the movements of domain walls.

Both of these concepts are going to be implemented on the new polarized single crystal diffractometer at FRM II named POLI (polarization investigator diffractometer).

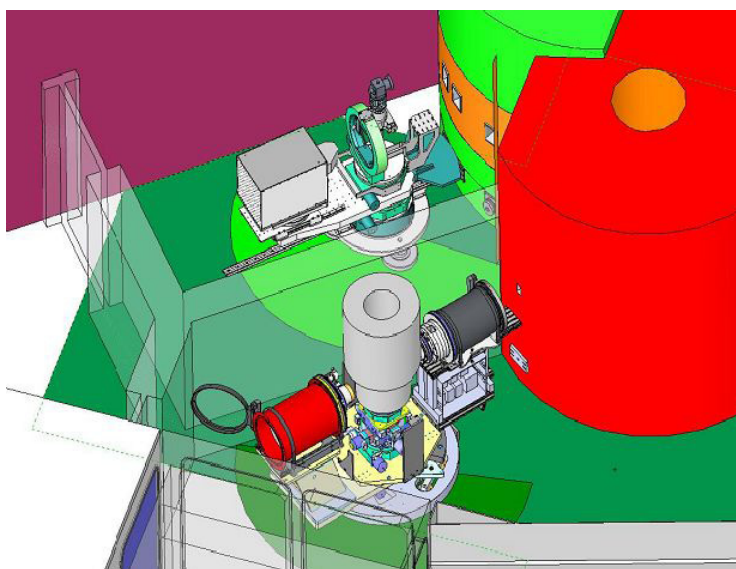

Figure 2: Design study for the independent operation of two diffractometers POLI and HEiDi at the hot neutron source.

The project to extend the existing single-crystal diffractometer HEiDi at FRM II has been ongoing since autumn 2004, carried out by the Institut für Kristallographie (RWTH Aachen) and financed by the BMBF. After a detailed investigation of the available options, it was decided to develop and build a separate secondary diffractometer with the ability to use the HEiDi monochromator. The

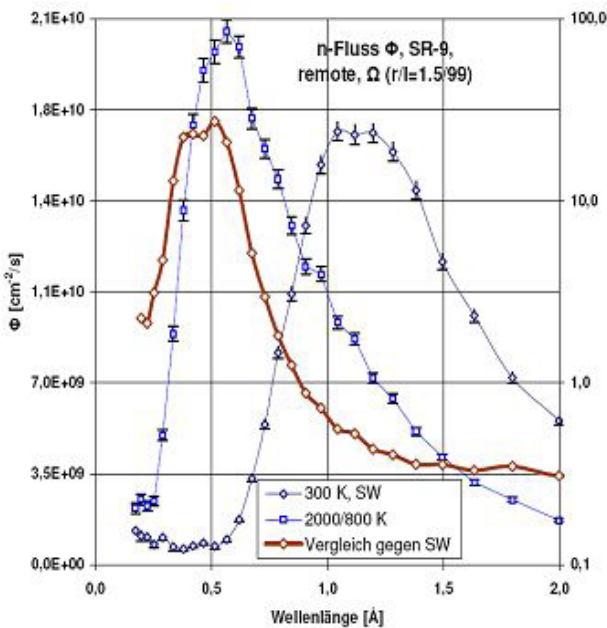

Figure 3: MonteCarlo simulations of the hot neutron source flux used for instrument design optimization.

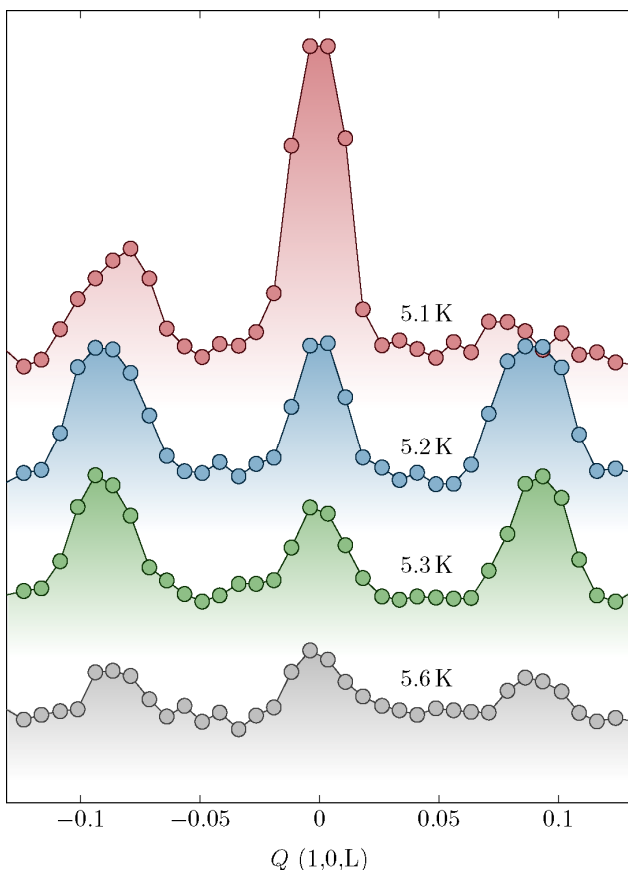

Figure 4: Temperature dependence of the commensurate CM (1,0,0) and incommensurate ICM-c* (1,0, ±0.085) magnetic peaks measured in antiferromagnetic superconductor $\text{HoNi}_2\text{B}_2\text{C}$ with POLI-HEiDi. The y-axis is plotted in the logarithmic scale.

polarization production as well as the polarization analysis uses ^3He spin filters. On one side this permits both polarized and non-polarized neutron diffraction using the same experimental conditions. On the other side the technique increases the polarized neutron flux and the instrument resolution for the short wavelength neutrons. A number of important parts as spin filter cells, magnetostatic cavities, nonmagnetic goniometer and zero-field polarimeter cryopad had been developed, built and incorporated in the new instrument in the last years.

SNP was successfully tested in 2010 and became available for the users of the FRM II. Taking into account the large demand on beam time for both polarized and non-polarized experiments (the actual overbooking factor at SR 9 is more than 3), it was decided to build a separate beam port for POLI on the available SR 9a channel. The project to build a monochromator, biological shielding and a different infrastructure to operate two independent diffractometers (HEiDi and POLI) at the hot source of FRM II was started in July 2010. The project is supported by the BMBF and granted with 1,2 Mio€ for the next three years. In 2013 the polarization investigator diffractometer POLI will become a fully independent instrument and so other polarization methods as PND using high magnetic field or maybe Larmor diffraction may be implemented. Until that time it uses the beam port SR 9b of the non-polarized HEiDi for about 30 % of the time and users interested in SNP or depolarization analysis have the possibility to use these techniques (therefore the double name POLI-HEiDi).

During the long shut down of the reactor in winter 2010-2011 the opening of the channel "a" at the SR 9 main shutter and the separation between SR 9a and SR 9b are planned. Parallel to this work the design of the new beam line and monochromator are optimized using McSTAS simulations. Preliminary results of this simulation show not only the good performance of the new instrument but serve also for further improvements on HEiDi.

Vladimir Hutanu, RWTH Aachen

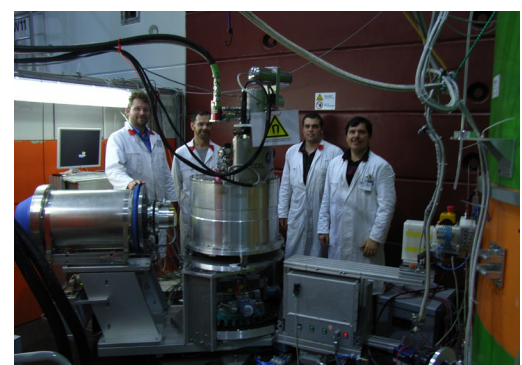

Figure 5: Technical feasibility study, test of the FRM II 7.5 T magnet on-site with POLI.

SANS instruments KWS-1 and KWS-2 for external users

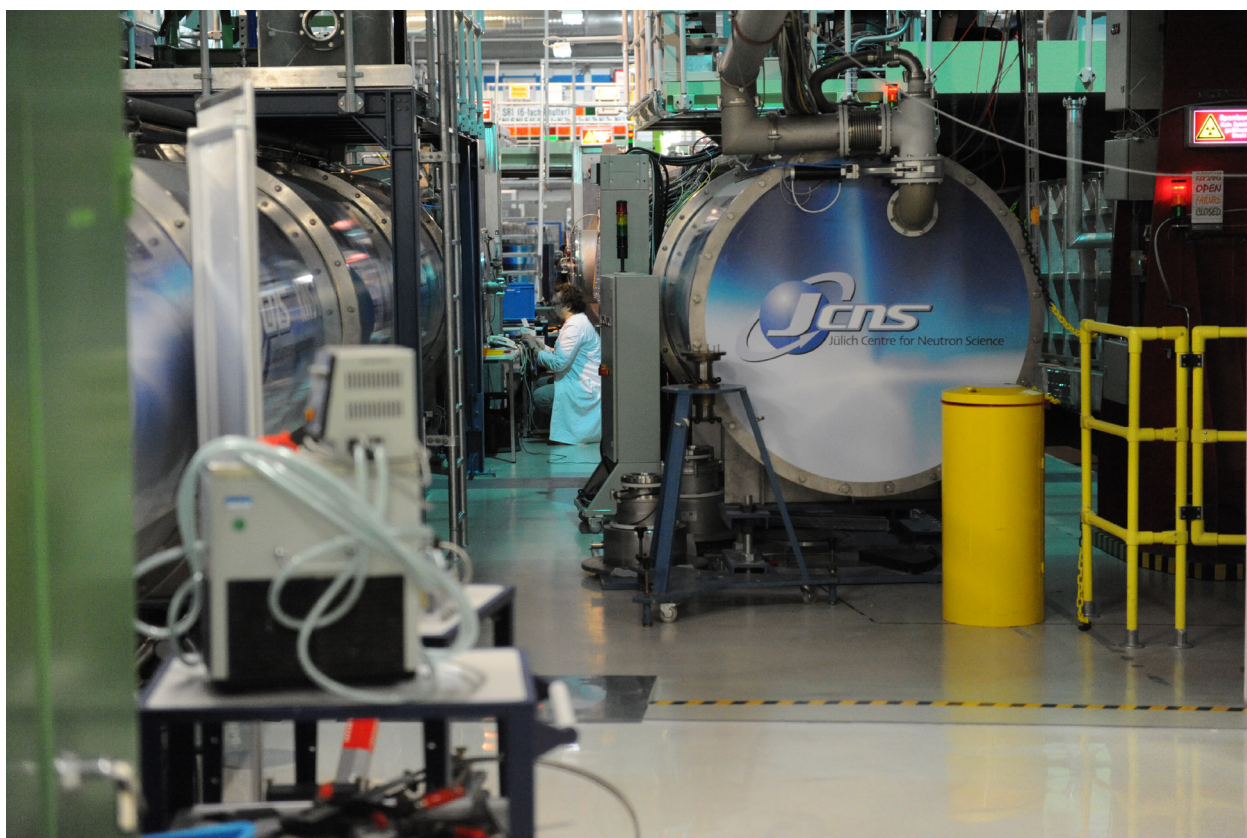

Figure 1: Scientist controlling the rheometer measurement at KWS-1.

The two small angle neutron scattering instruments KWS-1 and KWS-2 finish a successful year 2010 with many internal and external users. Scientifically interesting proposals were conducted in which the high intensity SANS instruments proved to be highly suitable – even for delicate and difficult tasks. Amphiphilic polymers are promising additives to enhance the efficiency of surfactants dramatically. For example, in tedious contrast variation measurements structural information about traces of polymers could be obtained. The structure of small proteins could be precisely determined with Q_{\max} up to 0.6 \AA^{-1} . Furthermore, provisional polarization experiments allowed to measure magnetic structures in thin films and to subtract the incoherent background of proteins in order to maximize the precision. KWS-1 became operational in December 2009 with a small delay due to the extension towards the old FRM, the so-called atomic-egg. From the very beginning, this instrument was provided with the full length of 20 m which is highly important for studies of large structures. The further developed collimation apertures allowed for stable heavy duty cycles, and the new detector electronics could deal with counting rates up to 0.5 MHz. The new rheometer with Searle geometry was taken into operation, and the liquid crystalline structure of microemulsions was oriented. The operation of the 1.2 T magnet allowed for the measurement of domains

structures in oxide dispersion strengthened steels. A provisional single mirror polarizer close to the sample position will provide preliminary use of polarized neutrons for magnetic thin films and incoherent background corrections.

KWS-2 is in user-operation since September 2007 in a short version with the maximum detector distance of 8 m. In order to correct this disadvantage a huge effort is currently undertaken, and the full 20 m detector distance can be offered to users in April 2011. Furthermore, a double-disk chopper will provide high resolution SANS measurements with a Q-resolution of typically 1 %. The new neutron lens chamber will be installed in parallel. The cooling of the lenses to 70 K will suppress parasitic phonon scattering.

A new 1.5 Tesla magnet was taken into user operation. The first users aimed at Y_2O_3 grains in oxide dispersion strengthened (ODS) steels. These steels are favourable for high temperature applications. The measurement succeeded to separate the magnetic scattering from surrounding iron grains from the Y_2O_3 grain scattering as shown in figure 2b for particle concentrations of 0.3 and 0.6 %. From this scattering curve the size distribution is calculated as displayed in figure 2c. The microscopic description of the particle distribution helps to understand the macroscopic strength of the ODS steels.

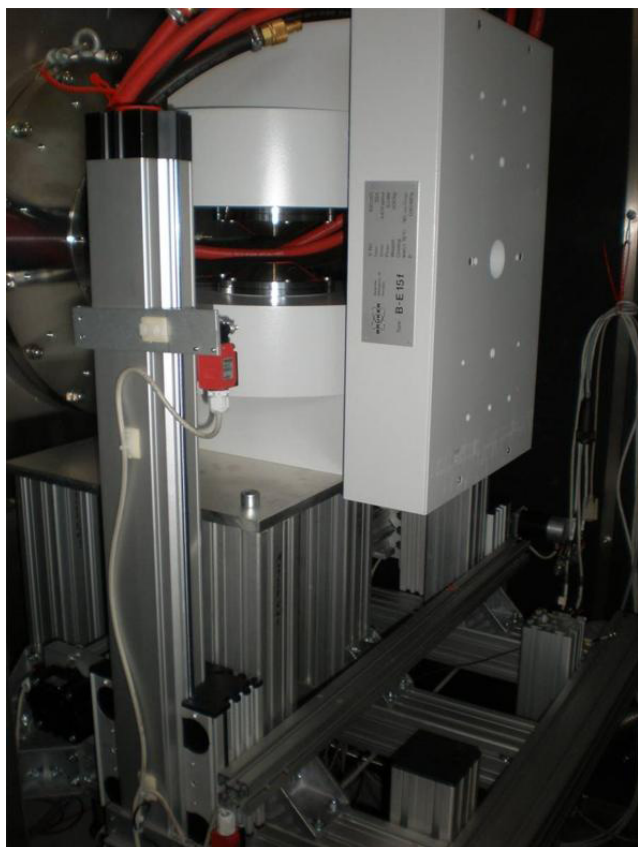

a

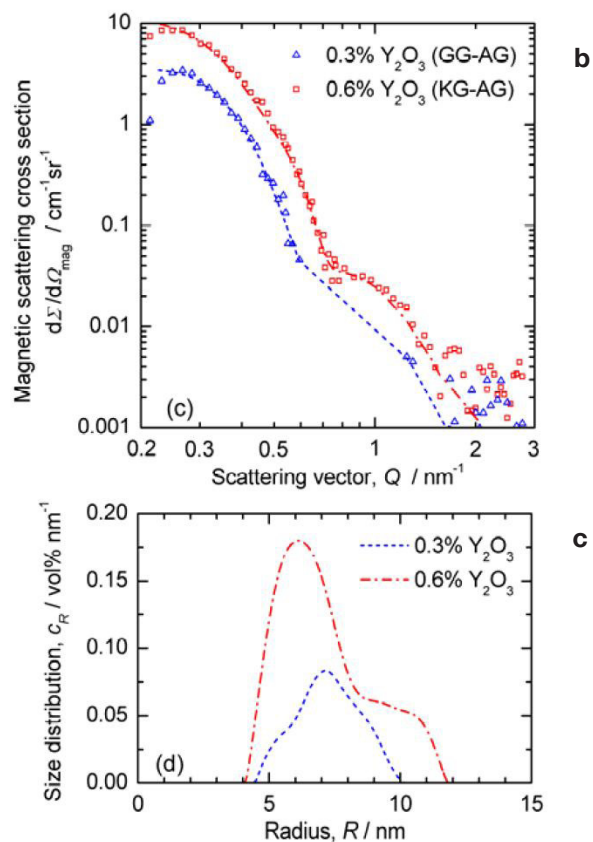

b

c

A new Searle rheometer was taken into user operation. The first experiments aimed at microemulsions in a liquid crystalline state where cylindrical micelles on a hexagonal lattice are formed. At a shear rate of 100s^{-1} we managed to align the sample macro-

Figure 2: (a) The new 1.5T magnet mounted on KWS-1. (b) First SANS measurements on Y_2O_3 grains dispersed in steel. (c) From the scattering curves, the grain size distribution is determined.

scopically. All cylinders are aligned horizontally along the velocity. From this viewpoint the order looks like a lamellar order with the second order peak at the double distance of the main peak. The alignment of the domains leads to the shear thinning effect which is favorable for easy pumping.

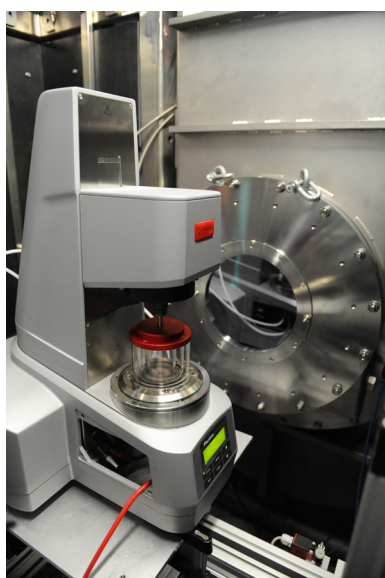

a

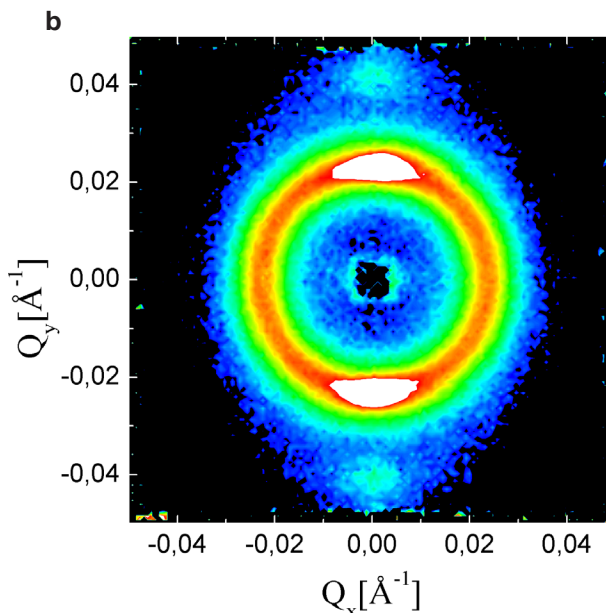

b

Figure 3: (a) The new Searle rheometer installed at KWS-1. (b) Scattering pattern of an aligned hexagonal cylinder phase of a microemulsion. Second order peaks indicate the high degree of order.

For 2011, we are looking forward to a heavy duty use of two small angle neutron scattering instruments with many delicate topics for highly ranked publications. While KWS-2 will be at its technically high level state, KWS-1 is foreseen to be upgraded by a chopper, neutron lenses and a polarizer with polarization analysis.

Henrich Frielinghaus, JCN

Neutron Larmor diffraction for materials science at TRISP



Figure 1: The users Michael Hofmann (TUM, 1. from left), Julia Repper (TUM, 3.) and the instrument scientist Thomas Keller (MPI, right) listening to the instructions of the instrument engineer Kathrin Buchner (MPI, 2. from left).

The analysis of residual stresses in engineering components using diffraction methods is a well-established technique. Neutron diffraction allows obtaining information from inside the bulk of a component due to the small total scattering and absorption cross-sections of most materials. The determination of the stress tensor is possible down to a typical depth of 10 cm and a spatial resolution of a few millimeters cubed without cutting and thus changing the stress state of a component.

Although the performance of neutron stress analysis diffractometers has improved continuously during the last decade, mainly due to focusing monochromators, neutron beam optical devices, position-sensitive detectors and advanced alignment techniques such as laser tracking and modern theodolite systems, the improvement in resolution has been rather small. In order to increase the resolution on a conventional neutron diffractometer (CND), the collimation and monochromaticity of the neutron beam have to be improved at the expense of a reduced detector signal. As the flux of modern neutron sources has not significantly increased since the construction of the ILL in the early 1970s, the art of diffractometer design was mainly determined by finding the optimal resolution versus flux relation for a given application.

This coupling between resolution and detector signal is circumvented by the Larmor diffraction (LD) technique suggested by Theo Rekveldt in close analogy to Feri Mezei's spin echo technique. The state of the neutron spin is used as an additional variable to store information about the momentum transfer during the diffraction process on each single neutron. This is achieved by placing magnetic fields around the sample, where neutron spin precesses while the neutron travels through these fields. By proper design of the field geometry, the net precession angle depends only on the relevant variable (the spacing of the lattice planes d in the case of diffraction) and is independent of the collimation and monochromaticity of the neutron beam. The resolution is then proportional to the total Larmor precession angle, which is only limited by the field homogeneity, and independent of the collimation and monochromaticity. High resolution of the order of $\Delta d/d = 10^{-6}$ and intense detector signals are achieved simultaneously.

The basic principle of LD is shown in figure 2. The elastic resolution ellipse of a conventional triple axis spectrometer in the $(hk0)$ plane was experimentally determined by scanning across a (110) Bragg peak of a perfect crystal (upper panel). The resolution for the lattice spacing d corresponds to the diameter of the ellipse as sketched in the colour coded intensity plot. Switching the LD fields on leads to a modulation of the resolution function (lower panel). One period of the modulation corresponds to a 360° spin rotation. As a few degrees of spin rotation can easily be measured, changes of the lattice spacing d or the position of the Bragg peak are detected with a resolution of about 100 times better than for conventional diffraction.

Lamor diffraction is a comparatively complex technique. It will not replace conventional diffraction, but it is a unique method in the high-resolution region not accessible by conventional methods. As the high resolution of LD enables both the determination of absolute d values and the spread of d values, there are several potential fields of application in materials science:

Lamor diffraction is a comparatively complex technique. It will not replace conventional diffraction, but it is a unique method in the high-resolution region not accessible by conventional methods. As the high resolution of LD enables both the determination of absolute d values and the spread of d values, there are several potential fields of application in materials science:

Lamor diffraction is a comparatively complex technique. It will not replace conventional diffraction, but it is a unique method in the high-resolution region not accessible by conventional methods. As the high resolution of LD enables both the determination of absolute d values and the spread of d values, there are several potential fields of application in materials science:

- small macroscopic stresses (type I stresses) as well as microscopic stresses (type II and III stresses) originating from defects or additional phases;
- materials with large Young's moduli, such as ceramics, where changes in the d values resulting from residual stress or external forces are often too small to be resolved with conventional neutron diffraction methods;
- precise determination of absolute values of the lattice spacing, which allows, for example, the analysis of lattice misfits in multi-phase material systems, e.g. in Ni base superalloys or metal matrix composites;
- separation of overlapping Bragg peaks;
- d_0 calibration of conventional stress analysis diffractometers. In addition these parameters can be studied under extreme temperature, uni-axial forces or hydrostatic pressure.

In a recent experiment (J. Repper et al., *Acta Materialia* 58, 3459–3467 (2010)) both absolute d values and fluctuations of d values were measured by LD for polycrystalline single-phase and multi-phase samples. The measurements on the Ni base superalloy Inconel 718 (IN 718) were conducted at the TRISP Triple-axis Spin-echo spectrometer at the FRM II. This instrument is designed for high-resolution phonon spectroscopy, and incorporates the possibility of performing LD. Initial LD experiments at TRISP concentrated on the thermal expansion of single crystals (i.e. relative changes of d) at low temperatures and hydrostatic pressure. A starting point for the present study was the observation that d values in IN 718 obtained by CND show a dependence on the sample diameter, which is not observed in LD. A further aim was to determine micro-stresses in differently treated IN 718 samples with varying content of additional phases precipitated in the Ni matrix phase.

The TRISP spectrometer used for the present study is not optimized for stress analysis as it does not have the precise slits and focusing devices necessary to select small gauge volumes. As currently no dedicated Larmor diffractometers exist, we propose for the future to equip an existing stress analysis diffractometer with polarizers and bespoke RF spin flip coils, in such a way that it is easy to switch between conventional and Larmor diffraction.

Thomas Keller, *MPI-FKF Stuttgart*
 Julia Repper, *FRM II*
 Michael Hofmann, *FRM II*

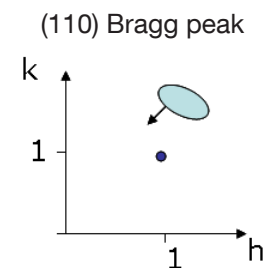
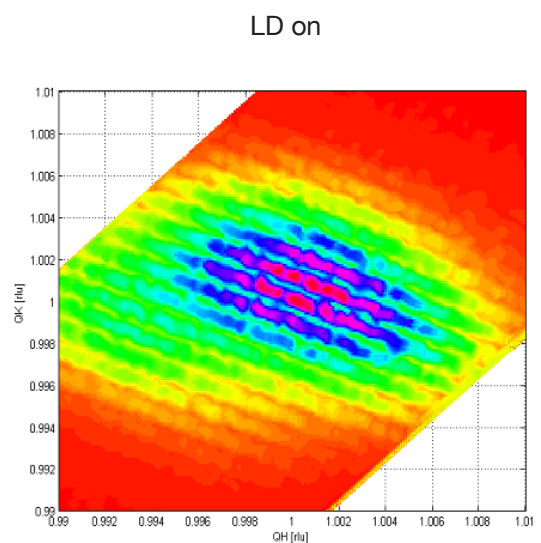
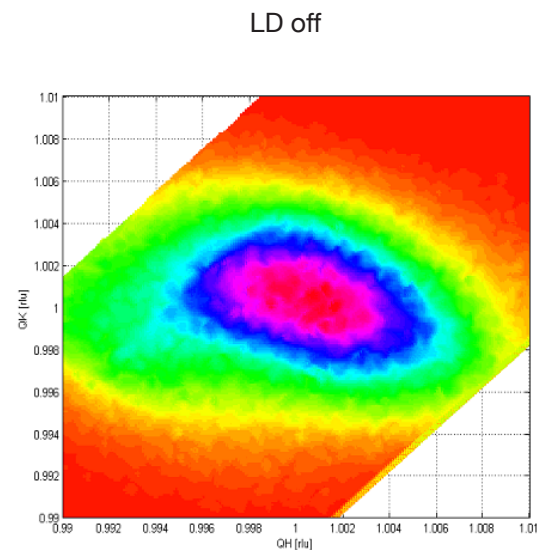

Figure 2: The basic principle of Larmor diffraction (LD), colour coded bragg intensity without LD (off) and with LD (on) (figure by K. Habicht, HZB). The modulation of the resolution ellipsoid increases the relative resolution $\Delta d/d$ by a factor 100.

New instrument for x-ray tomographies

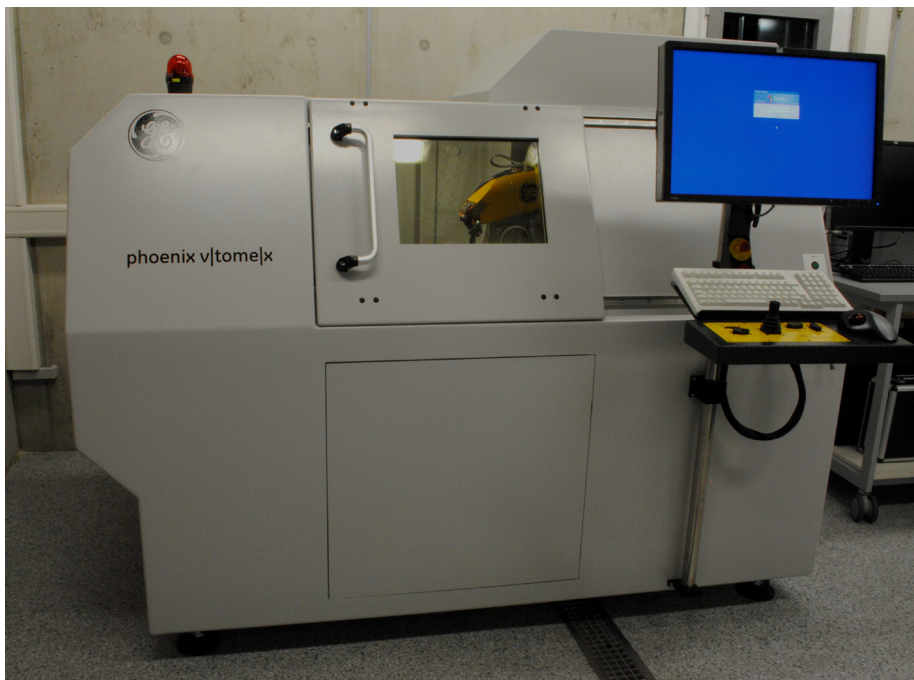

Figure 1: The new high resolution computer tomography facility.

In order to offer an x-ray facility complementary to the neutron tomography station ANTARES, the FRM II and the Chair of Biomedical Physics at the Technische Universität München have started to operate a high resolution computer tomography facility. The “micro CT VtomeX” is also available to users of the FRM II. Samples, that can be examined, include geo and composite materials, semiconductors and biomedical specimens.

First test measurements with a screw in rabbit bones simulating a metal implant show good results (see fig. 2). Usually, artefacts occur around metal implants in medical tomography. Using the new facility, on the contrary, the bone structure close to the screw is still well differentiated.

Possible scanning parameters

Max. sample diameter	230 mm
Max. sample height	420 mm
Min. resolution	<1 micron (isotropic)
Max. voxel size of reconstruction	2048 ³
Max. x-ray energy	240 keV
Max. sample weight	10 kg
Typical scanning time	1-120 min

Table 1: Features of the facility.

The x-ray tomography station is featured by its high flexibility: Due to two different exchangeable x-ray tubes, both, pictures with high resolution and pictures with lower resolution but higher contrast, can be taken. The detector allows for fast and highly contrasted pictures. The reconstruction of the data is accomplished within a few minutes due to a cluster of four computers using graphic cards to calculate the images.

Table 1 summarizes the features of the x-ray scanning service, that is offered by the Biomedical Physics. The local contact is Dr. Klaus Achterhold at the Department of Physics.

Andrea Voit, *FRM II*

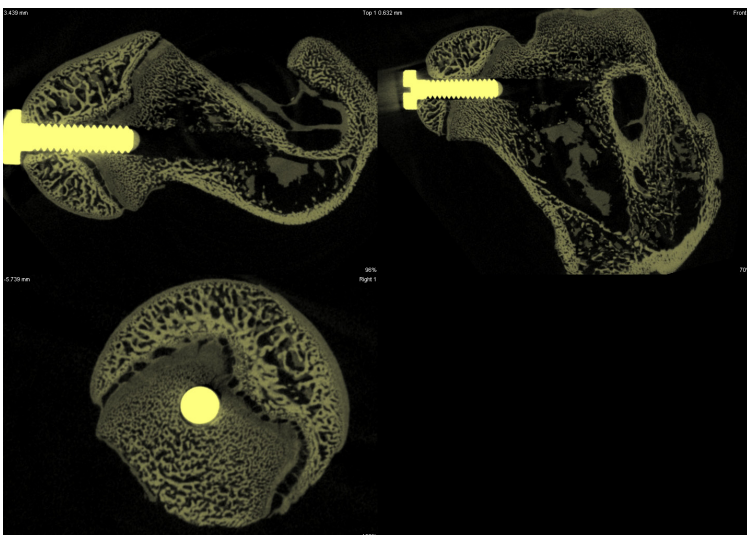

Figure 2: Rabbit bones with a screw.

Contact

Institute for Medical Engineering (IMETUM)
 Boltzmannstr. 11
 85748 Garching
 Germany
klaus.achterhold@ph.tum.de

NeT at the FRM II

June 10th-11th, 2010 - Garching

The 17th Steering committee meeting of the European network on neutron techniques standardization for structural integrity (NeT) took place at the FRM II in Garching on June 10th-11th, 2010.

The mission of NeT is to develop experimental and numerical techniques and standards for the reliable characterization of residual stresses in structural welds. Each problem examined by NeT is tackled by creating a specific task group which undertakes measurements, modeling studies and the interpretation of the results. The 25 scientists from Europe,



Japan and Australia met to review the status of those ongoing round robin exercises and to discuss future projects in the field of residual stress analysis and structural integrity. Subsequent to the meeting, the participants used the opportunity to attend a tour of the neutron source.

Michael Hofmann, FRM II

6th International workshop on sample environment at neutron scattering facilities

September 29th-October 1st, 2010 - Herrsching



From September 29th to October 1st the FRM II was host of the 6th International workshop on sample environment at neutron scattering facilities. Since the first workshop of this series has been held in Berlin in 1999 (initiated by Michael Meißner), the sample environment community meets every other year. The workshop is well established as an inherent part of international exchange of experience and cooperation. For the first time, colleagues from Japan and Korea joined the meeting indicating the increasing reputation of the meeting.

On September 29th sample environment experts representing ten different facilities as well as scientists and representatives from industry used the opportunity to get an impression of the capabilities and developments at the FRM II within the scope of a guided tour of the sample environment laboratories. Subsequent to the tour the workshop continued at the conference hotel "Haus der Bayerischen Landwirtschaft" located at the eastern shore of Lake Ammersee. State-of-the-art sample environment is a key ele-

ment for world class research using neutron scattering. More than 20 talks and a poster session outlined the progress and needs for further development of cutting-edge sample environment such as high pressure systems at low and high temperatures, ultra high temperature furnaces, novel soft matter sample cells, gas adsorption cells or sample change systems. Each topic presents a challenge by its own and demands a close cooperation of different laboratories bringing together specialized knowledge.

A specific session was dedicated to cryogenic-liquid free refrigerator systems especially regarding a future replacement of conventional wet systems like the still widely used so called *Orange Cryostat*. Besides the state of development, the availability of existing solutions and a standardization were discussed. The main advantages and benefit of such systems are the cost reduction and the ease of use. Furthermore general topics were discussed like the improvement of the service quality provided at the neutron scattering facilities as well as the cooperation among those different facilities. As a supplement to the workshop the bi-annual meeting on sample environment within the scope of the *European Integrated Infrastructure Initiative for Neutron Scattering and Muon Spectroscopy (NMI3)* took place. The fruitful discussions and the intense interchange may also be attributed to the inspiring and convenient atmosphere of the workshop location. The participants enjoyed also the workshop dinner at the monastery of Andechs.

Jürgen Peters, FRM II

Trends and perspectives in neutron scattering: Magnetism and correlated electron systems

JCNS Workshop 2010: October 4th-7th, 2010 - Bernried



Neutrons are a unique and indispensable aid for the investigation of magnetic phenomena and correlated electron systems. Thomas Brueckel of IFF's Institute for Scattering Methods pointed towards this tradition, when he gave a warm welcome to more than 80 scientists from all over Europe, the United States, Japan, China and Australia at the international workshop on *Trends and perspectives in neutron scattering: Magnetism and correlated electron systems*. The workshop took place in the small village of Bernried at Lake Starnberg in the vicinity of Munich, Germany, from October 4th to 7th, 2010. The meeting was organized by the Jülich Centre for Neutron Science (JCNS) in order to highlight latest achievements in the area in question and to discuss current trends and topics.

The workshop was very well attended and led to intense and fruitful discussions among the participants. Invited presentations were given by leading experts in the fields of frustrated magnets, quantum and low dimensional magnetism, magneto-calorics, pnictides, multiferroics and heavy fermions.

The main emphasis was placed on pnictides and multiferroics. Markus Braden and Daniel Khomskii (both University of Cologne) reviewed the state of the art in the investigation of multiferroic material by recent experiments as well as in theoretical concepts. Andrew



Boothroyd (University of Oxford) demonstrated the complementary use of x-ray and neutron investigations on these systems. Two sessions were devoted to the study of pnictides with presentations given by Andrew Christianson, David Mandrus and David Singh (all ORNL), Thomas Keller (MPI Stuttgart), Yixi Su (JCNS), Thomas Wolf (KIT), and Dirk Johrend

(LMU München). Each of them demonstrated the broadness in studies and results on this new class of superconducting materials.

Special sections were dedicated to new materials, sample preparation and novel instrumentation. The contributions emphasized the importance of the collaborative efforts by doing crystal growth, improving instrumentation as well as in depth data analysis of obtained results for high level research.



The poster session at the end of the second day gave the possibility to discuss the various topics in smaller groups. In the evening of the third day, the participants paid a visit to the monastery of Benediktbeuern and could take some refreshments: the conference dinner offered selections of traditional Bavarian cuisine and Bavarian beer. The workshop was concluded with a tour of the FRM II facility giving the participants a fresh view on latest achievements in instrumentation and capabilities of research.

The organizers greatly appreciated the support to the workshop by the participating industrial partners EADS Astrium, Oerlikon Leybold Vacuum, Pfeiffer Vacuum and SwissNeutronics.

Thomas Gutberlet, JCNS

JCNS LabCourse 2010

September 13th-17th, 2010 - Garching

60 registered participants joined the 14th JCNS Laboratory Course on Neutron Scattering.

The course took part from September 6th to 17th, starting with a one week theory course at Forschungszentrum Jülich and followed by a week of hands-on experiments and work at FRM II. The participants from German and European universities actively enjoyed the intense atmosphere of science at both places. In particular the combination of lectures in the first week and real experiments in the second week at Garching made a strong impression on most of the students, who not only came from a physics background but also from chemistry or biology. For many of these

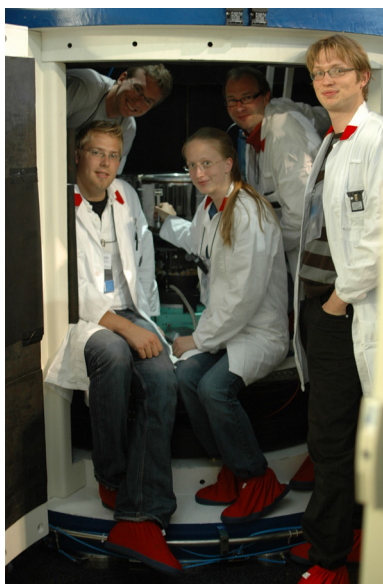

students it was the first experience with neutron scattering and working at scientific instruments at a large scale facility. Divided in small groups of about 5 students, a tutor and the instrument scientists worked closely with all participants, showing experiments and discussing measured data.

In addition to the scientific work also enjoyable evenings in Munich and a long lasting farewell party on Thursday evening made the 14th JCNS LabCourse an event to be remembered well by all participants.

Thomas Gutberlet, JCNS

Colloquium in honour of Tasso Springer's 80th birthday

October 14th, 2010 - Garching

The Jülich Centre for Neutron Science and the neutron source FRM II had invited to celebrate the 80th birthday of Tasso Springer. He is one of the forefathers of the neutron source in Garching. Unfortunately, the celebratee could not attend the colloquium on October 14th on grounds of ill health. Nevertheless, the 90 guests, former companions and scientists from Garching and Jülich, celebrated Tasso Springer cheerfully. The scientific director of the FRM II, Winfried Petry, spoke the welcome words and presented the scientific career of Tasso Springer.

Tasso Springer had started his career in neutron science by writing his diploma thesis and later his PhD with Heinz Maier-Leibnitz at the Technische Hochschule München (fig. 1). After having qualified as a professor, he headed for the new nuclear research centre in Jülich in 1963. In the following years, he got a professorship with the TH Aachen and was director of the Institut Laue Langevin in Gre-



Figure 1: Prof. Dr. Tasso Springer in the year 1956 at the beginning of the construction of the FRM, the first German research reactor at Garching.

noble, France. Back in Jülich as director of the institute for solid state research, Tasso Springer was part of many committees, amongst others the German science council since 1984.

The invited speakers, Thomas Thurn-Albrecht from the University of Halle-Wittenberg and Gero Vogl from Vienna, picked up topics of Springer's research in their talks: "Do we need polymer physics in order to develop better solar cells?" and "Neutrons, men and ideas following the tracks of chance". After the colloquium, the guests were invited to a Bavarian dinner in the entrance hall of the physics department.



Figure 2: Guests of the colloquium in the lecture room at the physics department.

Pictures and talks of the colloquium are online: www.frm2.tum.de/en/aktuelles/events/archive/festkolloquium-springer

Andrea Voit, FRM II



3rd FRM II user meeting

October 15th, 2010 - Garching

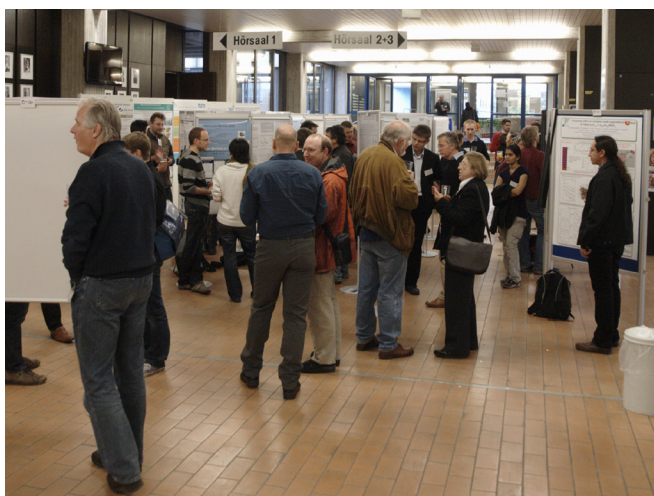

Jointly organized by the FRM II and the JCNS, the 3rd FRM II user meeting was held in Garching, Germany, on October 15th, 2010.

The FRM II started user operation in 2005 and the current user meeting reviewed five years of successful and growing user operation at this new facility. With more than 160 registrations the number of participants in the meeting demonstrated the active interest of the users in the FRM II. This interest coincides with the continuous increase in the number of users at the FRM II and the number of proposals for beam time.

This positive development was strongly reflected in the welcome to the participants by the scientific director

of the FRM II, Winfried Petry. In particular he pointed out that with two third of the available beam time at the FRM II devoted to external users not only German scientists profit from the facility but also users from all over the world with a share of nearly 40 %. With a still growing suite of instruments, e.g. the new BioDiffractometer for protein crystallography or the new reflectometer MARIA (see articles in this issue), which have both started commissioning recently, not only scientific users but also industrial users profit a lot from the available technical and instrumental opportunities at the FRM II.

Due to the limitation on one day only a small fraction of the more than 100 scientific presentations could be presented as lectures. Within these talks a broad overview of the various scientific areas investigated at the instruments at the FRM II was given, ranging from research on model membranes, dynamic of proteins, material sciences, magnetism, condensed and soft matter physics to new projects in fundamental physics. In all these areas the FRM II is a very valuable source for researchers from all over the world.

The tremendous poster session in the afternoon displayed many very detailed and exciting examples of research using neutrons, and, accompanied by Bavarian beer and finger food, led to long and intense discussions of the participating users and scientists from the FRM II towards the evening of this very successful event.

Thomas Gutberlet, JCNS

HOKO2010

November 3rd, 2010 - München

“Wow, I can work there!” This was just one of many positive responses to the booth of FRM II on the Hochschulkontaktmesse 2010 (HOKO2010). That is a job fair, which is organized yearly by the Munich University of Applied Sciences. The FRM II was one of 120 exhibitors introducing their institutes and companies to students and young professionals. Many of the students used the chance to discuss their opportunities to work at the FRM II within the frame of work experiences, working student positions and diploma, bachelor and master theses with three supporting employees working in different positions at FRM II: Dirk Etdorf, technician at the cold triple-axis-spectrometer PANDA, Herbert Weiß, member of the sample environment group, and Julia Repper, scientist at the spin-echo-spectrometer RESEDA.

The discussions were based on 27 job offers, which cover different subjects of interest ranging from mechanical and electrical engineering to technical physics and software development. Some of the students were



stoked about the performance of FRM II and applied immediately for work experience positions. The positive feedback of the students encourages FRM II to participate again at the next HOKO in 2011.

Julia Repper, FRM II

Internships at www.frm2.tum.de/jobs

IAEA Director General Amano and Bavarian Prime Minister Seehofer at the FRM II



Figure 1: Yukiya Amano listens to the explanations of Winfried Petry, Scientific Director of the FRM II (right), at a combustion engine, that was investigated with neutron radiography.

Two leading politicians visited the neutron source in July and October 2010. The Bavarian Prime Minister Horst Seehofer had his inaugural visit at the FRM II, and the Director General of the International Atomic Energy Agency, Yukiya Amano, started his tour in Germany by inspecting the neutron source.

Yukiya Amano referred to the FRM II as “one of the most modern nuclear facilities in Europe with robust safety and security features”. He was accompanied by the Bavarian State Minister for Science, Wolfgang Heubisch, the Member of the Board of Directors of the Forschungszentrum Jülich, Sebastian M. Schmidt, as well as the directors of the FRM II. Minister Heubisch welcomed the political visitor “at the neutron source with the broadest spectrum of applications in the world”.

At the guided tour, the Director General of the IAEA was especially interested in the medical applications of the facility. The FRM II will contribute to the Europe-

an supply with radioisotopes for the nuclear medicine to diagnose cancer. Mr. Amano was also impressed by the possibility to fight certain tumours by the treatment with fast neutrons at the FRM II.

In the experimental hall of the neutron source, the scientific director Winfried Petry explained how physicists explore material functions by using neutrons. Yukiya Amano showed a lot of interest in the large variety of research with neutrons at the FRM II.

Impressed by the national and international research at the FRM II was the Bavarian Prime Minister Horst Seehofer, when he visited the neutron source on July 26th for the first time. He enjoyed the visit of the facility in the company of the Bavarian State Minister for Science, Wolfgang Heubisch, the president of the Technische Universität München, Wolfgang Herrmann, and journalists. “It is obvious here, the investment of the Bavarian State into science bears fruits”, said Seehofer. The Bavarian State had paid the largest part of the 435 Mio€ construction costs of the neutron source.



Figure 3: TUM president Wolfgang Herrmann and the Bavarian Prime Minister (left) in front of the reactor building.

The president of the Technische Universität München, Wolfgang Herrmann, said: “The scientific world lines up to use the neutron source in Garching. By supporting the FRM II, Bavaria scores for Germany.”

Seehofer also commented on the planned conversion of the fuel element from highly enriched uranium (HEU) to medium enriched uranium (MEU). “We have a commitment to convert the FRM II, as soon as it is technically and scientifically possible. We take this agreement very serious.”



Figure 2: Wolfgang Heubisch and Yukiya Amano at the FRM II.



Collaboration agreement signed

Bayerisches Staatsministerium für
Wissenschaft, Forschung und Kunst



Bundesministerium
für Bildung
und Forschung

The Technische Universität München operates the Forschungs-Neutronenquelle Heinz Maier-Leibnitz in Garching on behalf of the State of Bavaria. Right from the beginning, the usage of the FRM II has been foreseen to be a national, German research infrastructure with open access to international research. To foster the national character of our neutron source, the Federal Ministry of Education and Research (BMBF) agreed with the Bavarian State Ministry of Science, Research and the Arts (StMWFK) to increase the budget for the scientific utilisation of the FRM II by means of a long term funding on the part of the BMBF. This initiative has been realized on December 17th, 2010, with the signature of a collaboration agreement between the TUM and the HGF neutron centres in Jülich (FZJ), Geesthacht (HZG) and Berlin (HZB). In total, about 20 Mio € per year will be invested additionally to promote the scientific research and user operation of the FRM II. This collaboration will start on January 1st, 2011, and will last for a first period of ten years.

The close collaboration of the HGF centres and the TUM will change the organizational structure of the FRM II. Today, it is governed by a director's board comprising the scientific, technical and administrative director, whereof the scientific director is the spokes man of the board. With the new organisation two scientific directors will take care of the scientific usage of the FRM II,

delegated by TUM and the HGF centres. At the beginning of the collaboration the additional director will be delegated by FZJ. Alternating every two years, either the TUM or the HGF director will be the spokes man. The nuclear operation of the neutron source will remain entirely to the TUM. The new directorate will be guided by a steering committee consisting of four members from the StMWFK and TUM and four members from the BMBF and HGF centres. The steering committee and the directorate will be supported by a scientific advisory committee consisting of 12 internationally renowned experts for neutron research. Despite the organisational issues the close collaboration of all German neutron experts at the FRM II promises a bright future of neutron research in Germany supported by a reasonable funding. The new organisational structure of the directorate will maintain entirely the idea of scattering instruments operated by university groups, Max-Planck society and research centres. For their engagement in the construction, maintenance and operation of the instruments, these groups dispose of one third of the available beam time for their own research, whereas the remaining two thirds will be distributed by the well established proposal system.

Jürgen Neuhaus, *FRM II*



Front row, from left to right: Thomas Federking (HZB), Ulrich Krafft (FZJ), Wolfgang A. Herrmann (TUM), Anke Kaysser-Pyzalla (HZB), Wolfgang Kaysser (HZG), Andreas Schreyer (HZG). Second row, from left to right: Dieter Richter (FZJ), Karl Eugen Huthmacher (BMBF), Wilhelm Friedrich Rothenpieler (StMWFK), Winfried Petry (TUM), Albert Berger (TUM).



Technische Universität München



Contribution to the design-update-phase of the ESS



Figure 1: Area view of ESS as designed by architects.

In a joint collaboration, centres of the Helmholtz Gemeinschaft and the FRM II aim to lead the German contribution to the design-update-phase of the European Spallation Source (ESS) in Lund. Funding for this project has been granted by the BMBF for the next three years, starting from December 1st, 2010. The total budget comprises 21 Mio €, whereof 6 Mio € are provided by the partners. The consortium is organized and managed by the Forschungszentrum Jülich (FZJ). In the design-update-phase all aspects of the ESS project will be revised. The German contribution is structured into five areas: accelerator components, target, in-

strument concepts, instrument components and management of the collaboration as sketched in figure 2. Whereas the large scale facilities in Hamburg (DESY), Karlsruhe (KIT) and FZJ deal with the core components of the source, the FRM II brings in its broad experience in using the neutron beams. Together with the experience of the other neutron centres in Germany, JCNS at FZJ, GEMS at Helmholtz Zentrum Geesthacht (HZG) and BENSC at Helmholtz Zentrum Berlin (HZB) a close collaboration on the development of new instrument designs and important components were established. Each of these topics as depicted in figure 2 is coordinated by one of the partners. A special focus in Garching will be the development of new spectrometers (I7, FRM II), the development of new large area detectors (K2, FRM II) and polarization analysis (K3, JCNS). Furthermore, we are strongly engaged in the development of concepts for imaging using a pulsed beam of the ESS. An imaging beamline is planned to be included in the day-one instrumentation of the ESS. The engagement of the FRM II in this consortium is the first step to realize the actions defined in the *Memorandum of Understanding*, TUM and ESS signed in May 2010. Starting with technical developments, it is envisaged to extend the collaboration with the ESS to scientific exchange, education in the area of neutron science and projects to use neutron beams for industrial applications.

Jürgen Neuhaus, FRM II

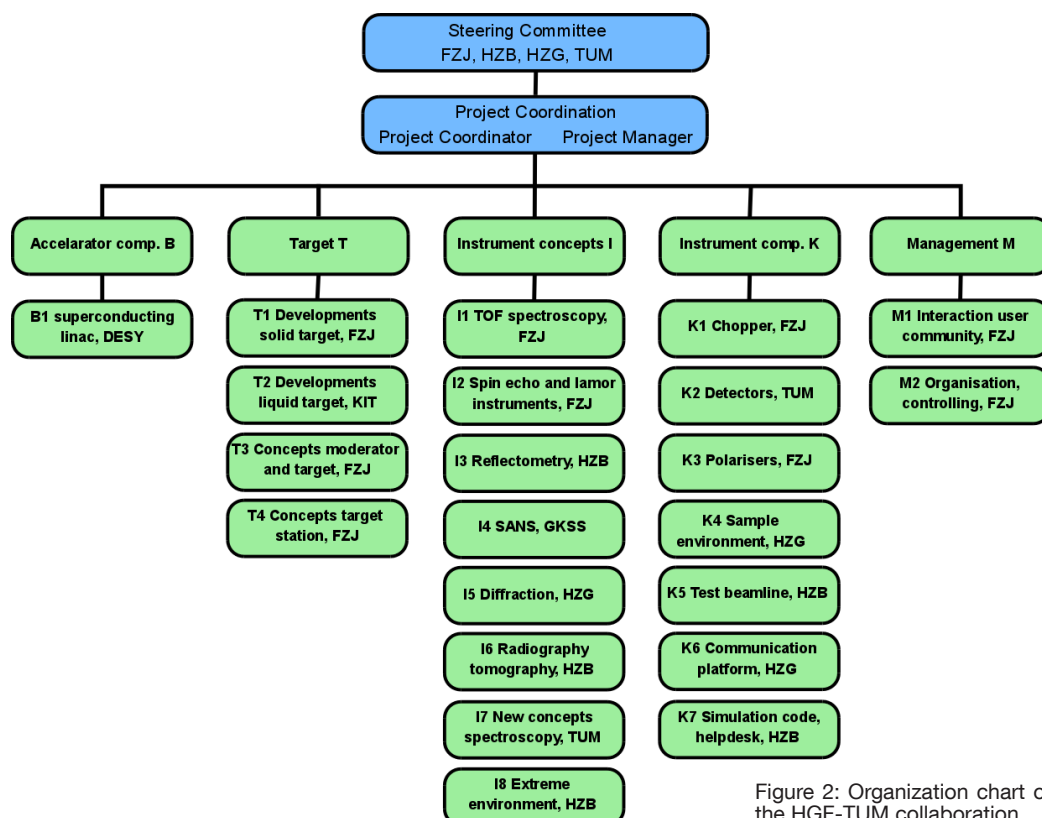

Figure 2: Organization chart of the HGF-TUM collaboration.

Industrial applications: From aeroplanes to stress analysis

Isotope production for medical and technical applications, silicon doping and testing of automotive components for higher quality - the neutron source Heinz Maier-Leibnitz (FRM II) was designed not only for scientific research but also for industrial applications. About 30 % of the neutrons are used by customers from industry. To present and discuss industry-related projects, the German association of engineers (VDI) and the FRM II organize the workshop "VDI expert meeting" on a regular basis. Representatives from both business and academia participate in the meeting to exchange experiences and discuss new cooperations (see *FRM II news No.4*).

A variety of industrial projects have already been carried out at the FRM II.

15 tons of silicon per year

The silicon doping facility generates the highest output in terms of weight and sales volume at the FRM II. Heiko Gerstenberg and his team irradiated almost 12 tons of pure silicon in 2010 which was shipped to customers in Denmark, Japan, China and Germany. The doped silicon crystals are used for high power thyristors and transistors commonly found in power plants for converting alternating current into continuous current. The latter is used to transport electric power over long distances, which is favourable for power lines covering more than 1,000 km.

Pure silicon is a poor conductor of electricity; therefore it needs to be doped with small amounts of phosphorus or boron. At the FRM II, the silicon crystals are irradiated with neutrons in one metre distance from the reactor core (fig. 1). A well determined dose of thermal neutrons is absorbed by Si atoms, which transforms by a nuclear reaction to phosphorus.

Protecting the environment

International customers are also frequently using another irradiation service at the FRM II: the neutron activation analysis (NAA) with the rabbit irradiation facility. This method exactly defines the composition of a sample. Depending on the sample, up to one atom in a trillion can be detected by NAA. For instance, it is used in environmental monitoring: the filters in the exhaust air of a chemical production facility were examined for the retained substrates to prove that the maximum permissible values for harmful substances have not been exceeded. Other customers used the service of the NAA



Figure 1: The silicon doping facility at the FRM II, while transporting a silicon crystal under water.

to define the purity of graphite or detect impurities in their materials.

Batteries for hybrid locomotives

New sources of energy for vehicles are rechargeable batteries. The US-company *General Electric* has started a research programme on rechargeable sodium/iron-chloride batteries for hybrid locomotives. The *General Electric* batteries are designed for energy savings of at least 10 % in a locomotive. Up to 10,000 of these 2.33 Volt batteries could provide hybrid locomotives with 2,000 horsepower. Unlike the lead batteries currently used in motor vehicles, sodium/iron-chloride batteries provide not only more than twice the power density, but they also have very high performance.

To examine the inner structure of these batteries at different charging states, they were measured at the instruments STRESS-SPEC (see fig. 2) and ANTARES assisted by FRM II's scientists Michael Hofmann and Martin Mühlbauer. Two battery cells were examined: one was discharged, the other one half charged. At the residual stress and texture diffractometer STRESS-SPEC, the measurements showed that the concentration of the metal, which acts as a reactant during the charging process, is higher on the edges of the battery than in its middle. Using radiography at ANTARES, the charging level of the sodium could be visualized (fig. 3). Knowing the distribution and concentration of the

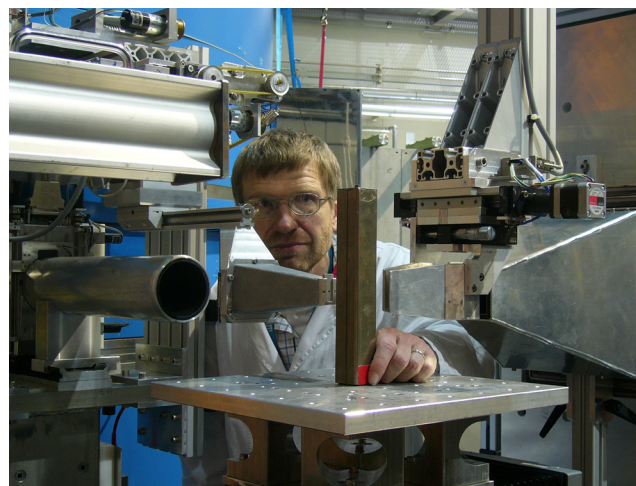

Figure 2: Michael Hofmann using the residual stress and texture diffractometer STRESS-SPEC to study batteries.

agent is important in order to establish, how the battery can be charged and discharged as often as possible. Neutrons can be used in a real-time analysis of the charging and discharging cycles of batteries to determine with even greater precision the distribution of sodium and other substances within the batteries.

Defining the filling degree of glue

Another industrial customer at the neutron source is the automotive manufacturer *Ford* studying the glue

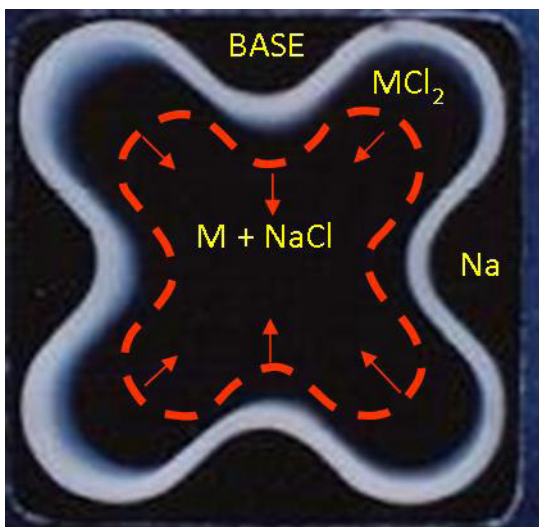

Figure 3: Radiography of a dissection of the battery cell. The reaction front moves during charging and discharging. The formula of the reaction is $2\text{NaCl} + \text{Fe} \rightarrow \text{FeCl}_2 + 2\text{Na}$.

in car doors, an important seal of the cabin against the outside, serving as corrosion prevention. The filling degree of glue inside car doors was measured by Maik Broder using different non-destructive methods for comparison. Out of five methods, the analysis with neutrons at the radiography facility ANTARES (operated by Burkhard Schillinger, FRM II) was the most suitable for detailed defect analysis, as the contrast and the illustration of the defects in the glue was excellent. Neutrons detect the H-atoms of the aqueous glue in the metallic surrounding of the car door with high precision. The resolution of 0.1 mm of the produced images was satisfying. Further analyses are to follow.

Moisture in aeroplanes

“Rain in the plane” is a common phenomenon in aircrafts, when they come in for landing. Water dripping down from the top of the cabin happens at times because of excessive moisture in the fuselage insulation. The moist breath from the passengers penetrates through the cabin into the insulation on the aircraft walls and condenses as water or ice on the cold outside wall. The temperature differences between -50°C at the outside of the aircraft and the agreeable

20°C inside the cabin lead to the condensation. This effects the plane negatively: the insulation suffers, mold can form, and the electrical system in the aircraft skin could short-circuit.

Instrument scientist Burkhard Schillinger (FRM II) helped Andreas Joos of the Technische Universität Hamburg-Harburg (TUHH) together with an industry

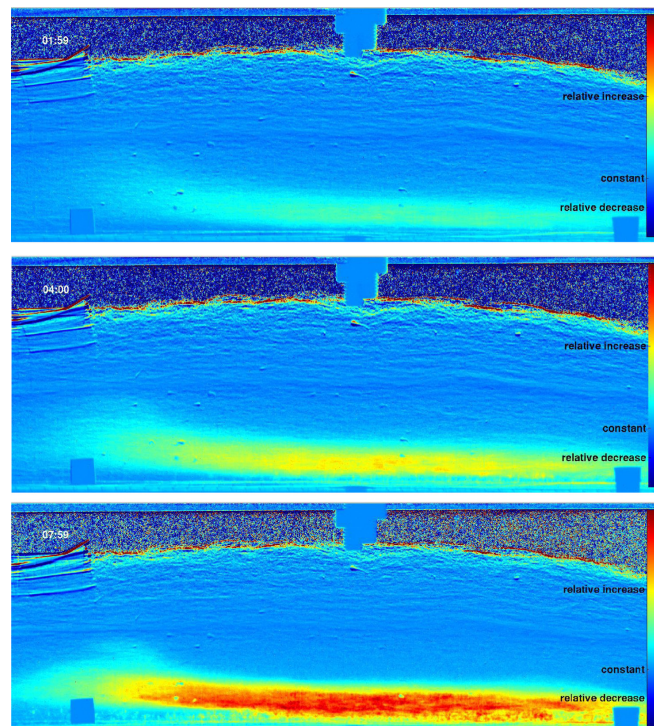

Figure 4: Graphics of the moisture in a section of the aircraft insulation at different times of the flight: 2 hours (top), 4 hours (middle) and 8 hours (bottom). The water accumulates at the outside wall (bottom of each figure) during time.

partner to study a section of an aircraft’s skin during a simulated transatlantic flight using neutron radiography. The aim was to find out, where and how moisture gets into an aircraft’s insulation and how to avoid this in the future. All of the temperature and moisture levels during a transatlantic flight were simulated. Neutron radiography at ANTARES revealed the precise locations of water and ice during the climbing phase, flight, descent and ground phase of the simulated flight (fig. 4). The next project is to build one model of an aircraft skin including a window and one with a support strut to find out how the water condenses at these different structures.

Andrea Voit, *FRM II*

Neutron induced disruption in MOS electronics

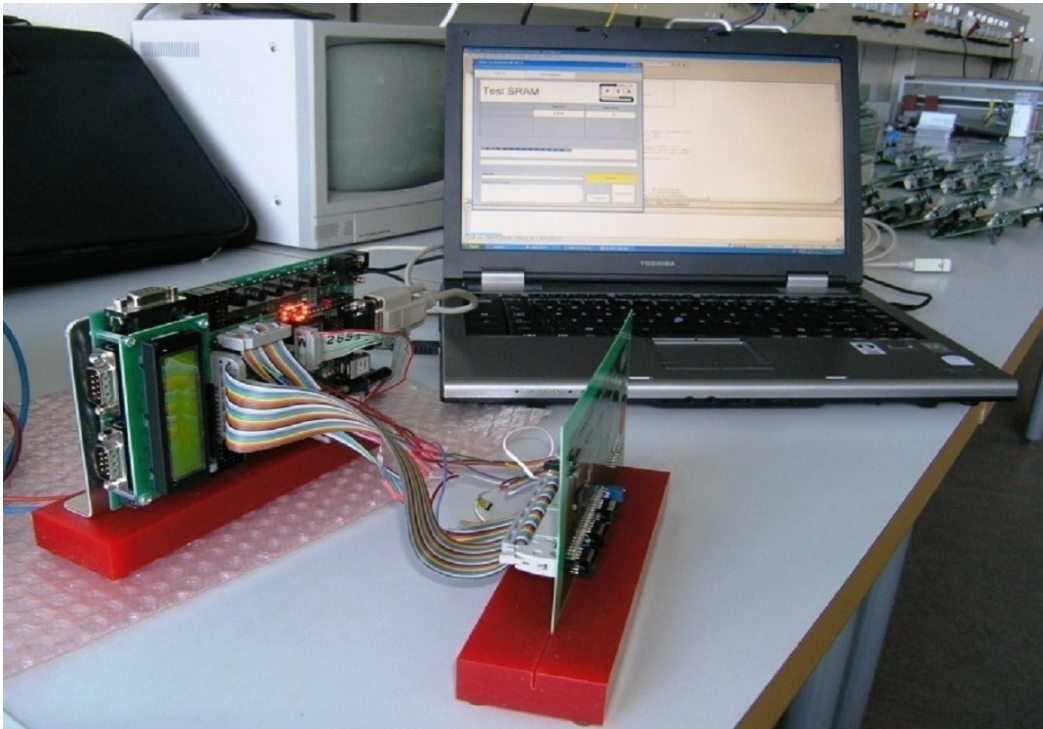

Figure 1: General experimental set-up with universal memory board in the foreground, micro controller and monitoring laptop used for the radiation tests of memory devices with different design and technology.

As part of weapon systems are required to comply to nuclear hardening specifications, the resistance of major electronic equipment against nuclear radiation has been investigated at the Bundeswehr Research Institute for Protective Technologies and NBC Protection (WIS) in Munster. Experiments indicate that in recent years miniaturization of electronic components comes along with increasing sensitivity to neutron induced disruption. In cooperation with the Helmut Schmidt University/ University of the Federal Armed Forces Hamburg (HSU), the influence of the neutron energy on sensitivities has been studied.

For special applications nuclear hardened components are already available from manufacturers. But generally, even vital electronic systems of modern aircraft consist of standard and therefore not explicitly hardened electronic devices. With higher flight altitudes the cosmic radiation is strongly increasing and a decent part of the radiation exposition has its origin in neutrons generated as secondary radiation. Due to this radiation, casual faults on the aircraft's electronics may appear. Especially inside of memory chips neutrons could induce bit errors. Beyond a nuclear weapon scenario - considering unavoidable cosmic radiation to be a threat to the aircraft's electronics, sufficient nuclear radiation resistance is a topic. With respective testing using available neutron sources, it can be investigated which parts

of equipment are endangered by neutrons in particular.

WIS and HSU jointly investigate the resistance of micro controllers and static memory components (SRAM) to nuclear radiation, particularly with regards to neutron induced **Single-Event-Effects (SEE)**. Experiments are performed at facilities of WIS as well as at the neutron source FRM II of the Technische Universität München.

Ionizing radiation and neutrons are the reason for different effects on electronics. One of these effects is

the generation of **Single-Event-Upsets (SEU)**. It can be caused by an impact of only one single neutron in the region of the channel (region under the gate) of a MOS-FET (**Metal Oxide Semiconductor Field-Effect Transistor**). The neutron interacts with the semiconductor material and creates a strong ionizing particle in the channel of the MOS-FET. Due to the voltage drop between source and drain a short current pulse travels through the channel. This current can cause a data corruption in a memory cell of a SRAM. This event is called SEU as a special kind of a SEE. In case that this happens in more than one memory cell, it is called **Multi-Bit-Upset (MBU)**.

In the framework of SRAM testing, several types of representative standard devices have been chosen

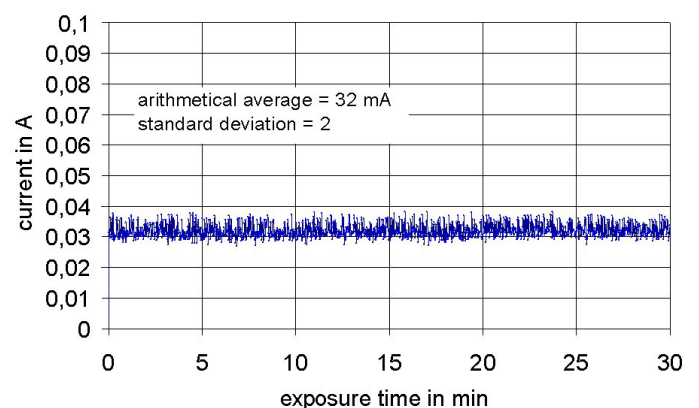

Figure 2: Current profile at the memory device during the radiation, no neutron effect detectable.

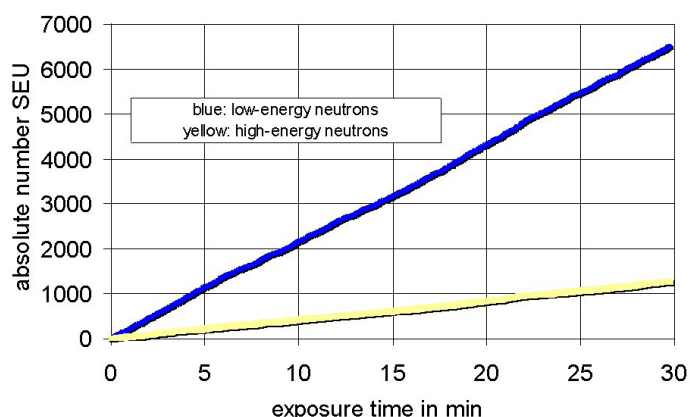

Figure 3: Neutron irradiation of a 4 Mbit SRAM device. Appearance of single-event-upsets (SEU) over a exposition period of 30 minutes. This correlates with $5,1 \cdot 10^{11} \text{ n/cm}^2$.

for radiation testing. Each type is tested in numerous numbers. A specific test set-up has been developed to gather reproducible and comparable data (fig. 1).

Before the irradiation experiment, defined data were written into the memory under test, which are then subsequently read out and checked for consistency frequently during the irradiation procedure. Every inconsistency is counted and registered. This approach allows generally a functional analysis in real-time, and the detection and discrimination of SEU and MBU. The test set-up allows also detecting latch-ups. This is a short-circuit due to triggering parasitic 4-layer structures within the microstructure of the MOS-FET. To document possible latch-ups, the current drain under test is being tracked and recorded (fig. 2). Components are irradiated by neutrons with three different

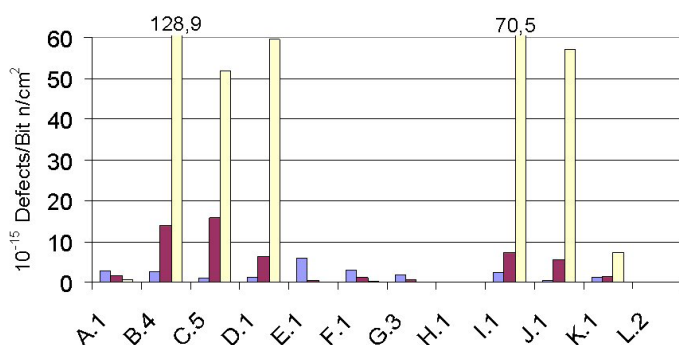

Figure 4: Comparison of the SEU defect trend of different SRAM devices exposed to varying kinetic energies of the neutrons. (yellow: low energy neutrons, red: thermal neutrons, blue: high energy neutrons).

kinetic energies, with fast (direct radiation), thermal (moderated), and with cold neutrons. For the test with fast and thermal neutrons the FRM II converter facility is used and for the cold neutrons the radiography station ANTARES. Moderation is done by using polyethylene sheeting. During each radiation test the amount

of bit errors versus time of exposition is measured (fig. 3). Due to the constant neutron flux, the irradiation time is a scale of the neutron fluence.

In general, the data acquired suggest a characteristic and approximately linear evolution of errors. It can be fundamentally realized that, on the one hand, the sensitivities differ by devices. On the other hand, the sensitivities also differ by the kinetic energy applied (fig 4). Some types are quite sensitive to cold neutrons, but rather decreasingly susceptible at increasing kinetic energies. Conversely, some other components are unsusceptible to cold neutrons. In contrast, components declared by the manufacturer to be tolerant or resistant to radiation prove to be equally insensitive to all kinetic energies tested. The same applies to representative samples based on FRAM-technology (ferroelectric SRAM). Additionally, the SRAMs are tested with very high gamma dose rates up to $3 \cdot 10^6 \text{ Gy(Si)/s}$ on the flash x-ray machine of WIS. During this test no SEU or any other SEEs were observed.

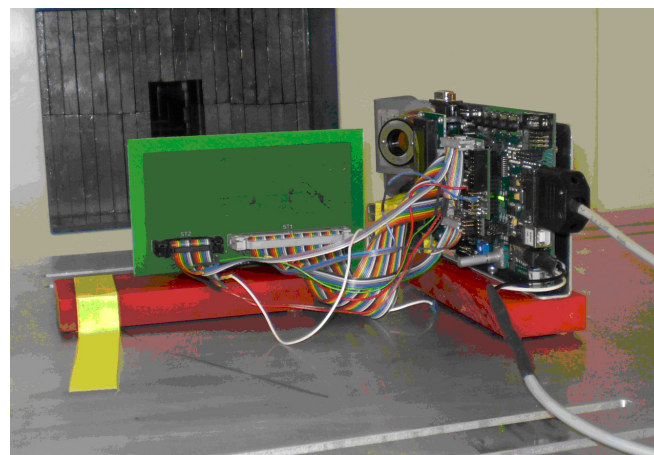

Figure 5: Test set-up for fast neutrons at the FRM II converter facility. The green memory board is positioned with the SRAM in the center of the beam axis. On the right hand side one can see the micro controller board and a pyrometer, which monitors thermal behaviour of the tested SRAM.

Overall, samples of the same type of components react reproducibly when irradiated at specific energies. Then, similar numbers of bit errors are measured. Focusing on their sensitivities in particular, when exposed to neutrons with different kinetic energies the converse behaviour of the SRAM devices can not be traced directly to obvious exterior criteria. For doing this, an analytical investigation of the elementary structure based on CMOS technology is needed focusing on the devices' sectional images. The use of electron microscopy and ion beam technology allows structure imaging in the nanometer region.

From the bulk to the atomic scale

Research with neutrons at E21

The scientific activities covered at the institute E21 at the Physik-Department of TUM are strongly focused on the investigation of the magnetic and superconducting properties of strongly correlated electron systems. For sample preparation, E21 operates at the Physik-Department various laboratories for crystal growth and materials characterization to study bulk properties under extreme conditions. In addition, E21 runs four beam lines at the FRM II to complement the bulk measurements with microscopic techniques. This unique zoo of experimental tools gives E21 the opportunity to investigate novel materials within a short time.

In the following, we show with a few examples some of the most salient results that were gathered by members of E21 at the FRM II.

ANTARES

Neutron Depolarization Imaging (NDI) is a powerful tool for the non-destructive determination of the magnetization distribution in materials. The highly collimated neutrons at ANTARES in combination with ^3He polarizers (fig. 1) make it possible to image the distribution of the Curie temperature T_C in inhomogeneous $\text{Pd}_{1-x}\text{Ni}_x$ single crystals much more efficiently than by using bulk techniques. The results support the theoretical prediction that the phase transition in ferromagnets becomes 1st order near the putative quantum phase transition. In addition, NDI provides valuable information on how the growth process of the crystals can be improved to produce homogeneous single crystals of high quality. The next step in improving NDI will be the implementation of spherical polarization analysis to distinguish depolarization and spin-rotation effects unambiguously.

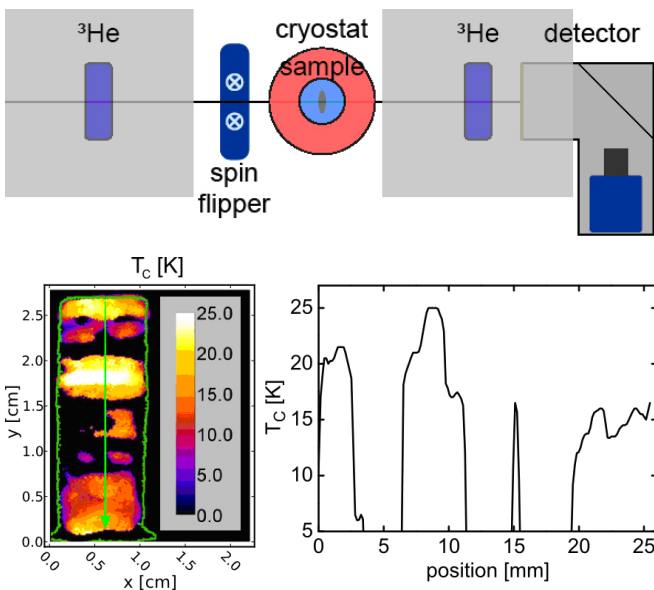

Figure 1: (top) Schematic setup for polarized neutron radiography using ^3He cells (top). False color image showing the distribution of T_C (bottom left) and a plot of T_C as extracted along the green arrow (bottom right).

MIRA

When approaching quantum phase transitions, excitations with very small energy scales become important for the formation of the groundstate. Using conventional neutron scattering techniques, the required high energy resolution cannot be easily obtained in magnetic fields. Recently, we installed at the beam line MIRA a turn-key MIEZE module (fig. 2) that allows conducting neutron scattering with a resolution better than 0.1 μeV in magnetic fields exceeding several kG.

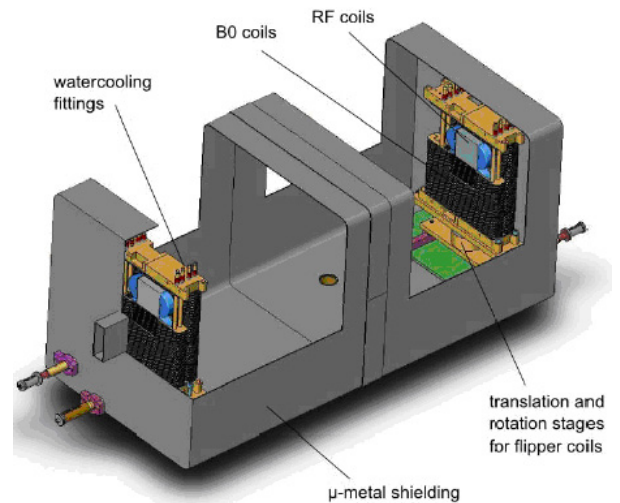

Figure 2: The “MIEZE” box as installed at MIRA for high resolution experiments in MnSi.

One of the first experiments using MIEZE was the confirmation that the skyrmion lattice in MnSi as induced by a field of 0.18 T at 28.5 K was indeed static. While the life time of the fluctuations at the magnetic Bragg peak decreases with increasing T when the long range order is lost (fig. 3), the contrast of the MIEZE signal does not visibly change between the helical and the skyrmion phase proving that the induced skyrmion lattice is a stable phase exhibiting long range magnetic order.

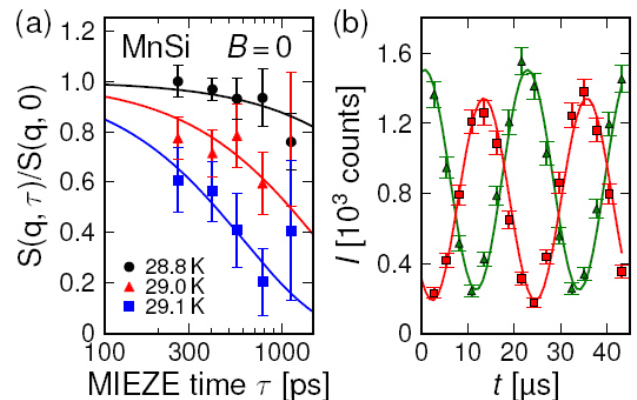

Figure 3: (a) Normalized intermediate scattering function in helimagnetic MnSi near $T_C = 29$ K. (b) Time dependence of the neutron intensity in the helical (red, $B = 0$ T) and the skyrmion phase (green, $B = 0.18$ T).

RESEDA

At the transition from the helical to the paramagnetic phase of MnSi and its alloys the coexistence of a long range helical magnetic phase and a dynamic phase is observed in a narrow window of T at T_c . Neutron resonance spin echo spectroscopy is ideally suited

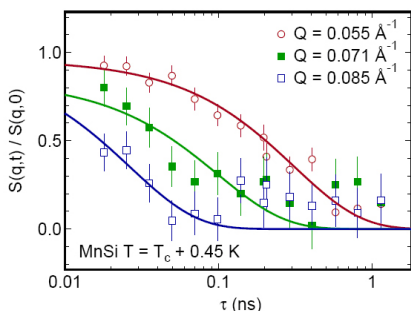

Figure 4: Spinecho data from MnSi above T_c . The life time of the fluctuations decreases quickly with increasing momentum transfer Q .

to determine the time scale of the magnetic fluctuations. The results shown in fig. 4 demonstrate that the decay of the magnetic fluctuations speeds up with increasing momentum transfer Q . The available time- and Q -scales at RESEDA are ideally suited for studying magnetic fluctuations at small Q .

NEPOMUC

As part of the Transregio TRR 80, it is planned to install at NEPOMUC a facility for measuring the Angular Correlation of the Annihilation Radiation (ACAR) of positrons enabling the determination of the electronic structure and the Fermi surface in correlated materials.

In a test experiment at POSH in Delft, the two-photon-momentum distribution (TPMD) from a Heusler single crystal grown at E21 was measured in the (100) plane. The TPMD (fig. 5) does not show a full 4-fold symmetry as expected. This feature was observed at the surface *and* in the bulk of the crystal. The mechanism which leads to the suppression of the 4-fold symmetry is not yet understood. Theoretical calculations are currently performed in order to interpret the experimental data.

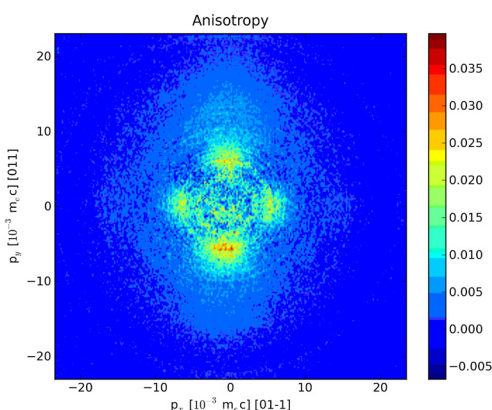

Figure 5: The two-photon-momentum distribution in the (100) plane of a Heusler crystal.

KOMPASS

Due to a lack of a powerful triple axis spectrometer with spherical polarization analysis for the investigation of non-centrosymmetric crystals, a triple axis spectrometer with advanced neutron optics is being installed in the neutron guide hall in collaboration with the Universität zu Köln. The primary flight patch consists of a parabolically focusing guide delivering a beam with a high polarization $P = 99\%$ (fig. 6).

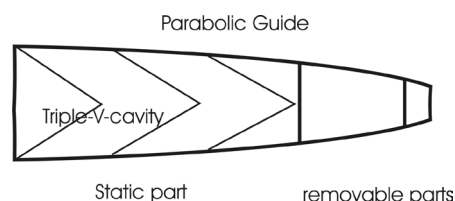

Figure 6: A parabolic guide including polarizing cavities supplies a highly intense beam with high polarization to the focusing monochromator.

Fig. 7 shows that the advanced optic design of KOMPASS provides significant gains in flux and resolution when compared with a straight guide. KOMPASS is supported by BMBF.

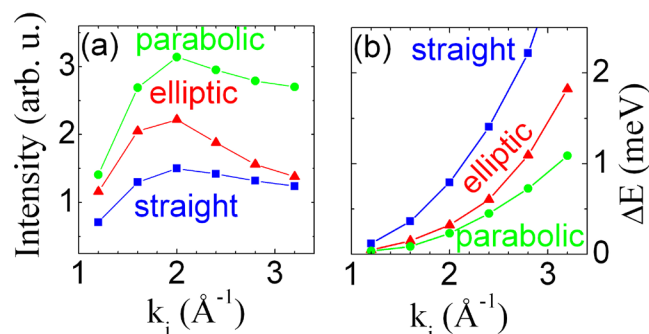

Figure 7: The Monte-Carlo simulations show the rather dramatic gains in intensity and resolution.

The above examples presented an overview of typical work of E21 at the FRM II. Part of it was only possible thanks to the direct involvement of research assistant students from TUM. The next developments of E21 at FRM II will be directed towards the implementation of new focusing techniques combined with efficient detectors and spherical polarization analysis to investigate strongly correlated electron systems in extreme environments.

Peter Böni, TUM

PERC – a bright source of neutron decay products

Free neutrons decay into electron, proton and anti-electronneutrino. Although this process is known for many decades, its precise experimental characterization provides a wealth of information for particle physics. In the Standard Model of particle physics (SM), the correlations between the decay products and the spin of the decayed neutron are described by one complex parameter λ , the ratio of the axial-vector and the vector coupling constant. The imaginary part of λ is negligible in the SM, leaving only one parameter to be determined experimentally. On the other hand, many experimental correlation coefficients can be defined in neutron beta decay, the beta asymmetry A (correlation between neutron spin and electron momentum), the proton asymmetry C , or the Fierz parameter b (a contribution to the precise shape of the beta spectrum), to name a few. All these observables depend only on λ or are zero in the SM. However, the SM cannot explain many observations in the Universe and alternative theories have been brought up. These theories contain additional parameters that would lead to changes in the observable correlations with respect to the predictions of the SM. Precise measurements of several correlations in neutron decay check the consistency of the SM or may identify a theory that describes reality better. These experiments are complementary to high energy physics. Presently, correlation measurements in neutron decay are limited statistically, but also by several systematic effects, to a relative accuracy of about 10^{-3} . The PERC (proton electron radiation channel) instrument, proposed by D. Dubbers, is designed to overcome these limits. It combines the following concepts:

- Charged neutron decay products are collected by a strong magnetic field. This technique has been used by other neutron decay instruments (Perkeo I-III, aSPECT), provides a well-defined detector solid angle, and suppresses the background.
- Neutron decay is observed inside a neutron guide. This new concept allows to preserve the full phase space density of neutrons delivered by the primary guide and thus provides the maximum possible statistical sensitivity.
- A magnetic mirror field of about 4 times the collect-

ing magnetic field defines the phase space of the observed decay products precisely. This technique has not been used before. It reduces several systematic effects.

Systematic effects for electron spectroscopy and asymmetry measurements have been shown by D. Dubbers (et al., Nucl. Instr. Meth. A 596 (2008) 238 and arXiv:0709.4440), to be below 10^{-4} for PERC, with the exception of neutron beam polarization. PERC is a versatile instrument providing a clean and bright beam of charged neutron decay products. The users can concentrate on the construction of secondary spectrometers and do not need to worry about the neutron beam any more.

PERC is funded by the priority programme *Precision experiments in particle- and astrophysics with cold and ultracold neutrons* (SPP1491) of the Deutsche Forschungsgemeinschaft. It will be built in a collaboration of Universität Heidelberg, Technische Universität Wien, Institut Laue Langevin and Universität Mainz at the FRM II. The project comprises several challenging technical developments: A superconducting magnet of 8 m length with a well-defined field shape between 2 and 8 T will be designed by the groups in Heidelberg and the Wien. A group in Heidelberg will develop a supermirror guide without depolarization. The ILL will bring in its unique experience with polarization techniques and polarization analysis and improve the presently available accuracy by one order of magnitude. As first step in this project, we have demonstrated in an experiment at the ILL's instrument PF1b that polarization analysis with ^3He spin filters is accurate to better than 10^{-4} . Further projects include the development of a novel secondary magnetic spectrometer for electron spectroscopy (Wien), complementing the presently used calorimeter-based spectroscopy, or the investigation of detectors and techniques for low-energy proton spectroscopy (Mainz, ILL). The FRM II will design and construct a dedicated neutron guide and relocate the beam station MEPHISTO into the new neutron guide hall east. Furthermore, it will contribute related infrastructure (velocity selector, polarizers, etc.).

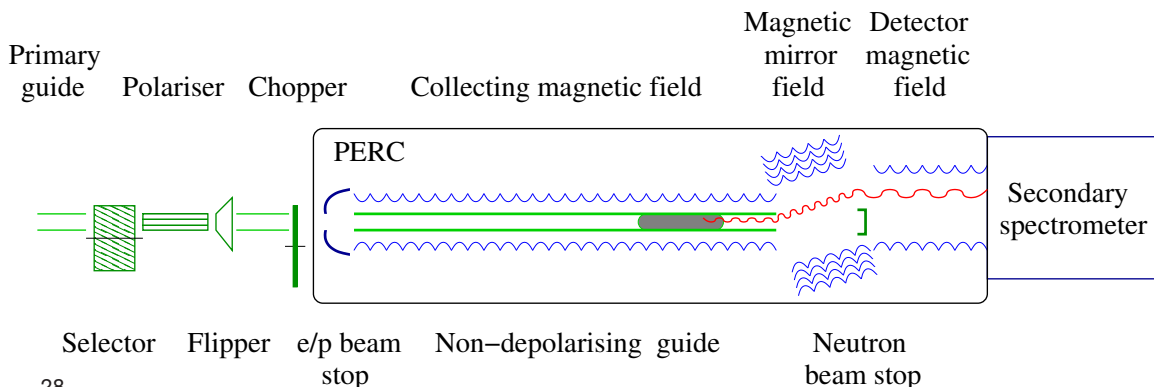

Torsten Soldner, ILL

Principle setup of the PERC instrument, shown for a polarized pulsed neutron beam. The magnetic fields are created by superconducting coils. Depending on the observable, different secondary spectrometers and unpolarized or continuous beams will be used.

Software and hardware at its best

The IT-services group

Making the scientists' life easier by creating a set of modules to be used for different solutions – this is the motto of the IT-Services group at the FRM II. Jens Krüger, head of the group, and his seven colleagues deal with various different tasks each day: They range from wiring new computers to developing new software for the operation of an instrument. Briefly, both software and hardware problems are solved.

In addition, six apprentices support the IT-services group. They are trained in two different apprenticeships: called “Fachinformatiker Systemintegration” and “Fachinformatiker Anwendungsentwicklung”. FRM II trains them in order to have its own offspring for IT-services. Besides, many of the apprentices get a well-paid job in industry after having finished their training.

The division of the two apprenticeships reflects the two parts of the IT-services: One part of the group handles the hardware at the FRM II and administers the computers, central servers, and network infrastructure, the other one develops new software for instruments, for the digital user office, and for management of the reactor operation like the management of the periodic checks.

As a user at the neutron source, the contact with IT-services often remains unperceived. It starts, when registering with the user office and continues on the first day in Garching, when handing in the passport at the registration office. The data at the registration are administered by IT-Services. Of course, the username for the login in the FRM II network is handed out by the group, too. The unperceived contact continues with the data collection at radiation protection. And finally, the software to operate about 80 percent of all instruments in the experimental and neutron guide halls is provided by IT-services. “Our goal is to offer

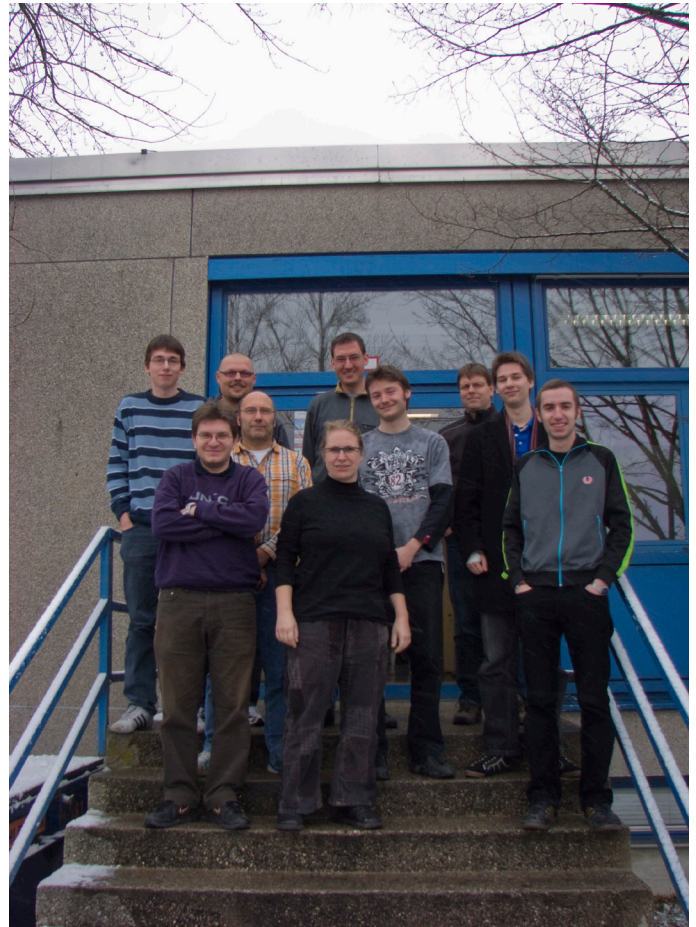

service, so that the scientists can proceed with their work without being interrupted or disturbed by any IT problems”, says Jens Krüger.

For the instruments' operation the FRM II IT-services plan to change from TACO to TANGO. The latter is a successor of TACO also an object oriented distributed control system. In contrast to TACO, TANGO allows to change the operation mode from a polling system to an event driven system which may drastically reduce the system load. In cooperation with various synchrotron sources (ESRF, ELETTRA, DESY, SOLEIL, ...), the FRM II IT team takes part in the development of the TANGO system. Meanwhile, the existing TACO is being further improved. Jens Krüger and his colleagues benefit from the fact, that many instruments have similar applications and therefore once created modules can be used in different situations.

Andrea Voit, *FRM II*

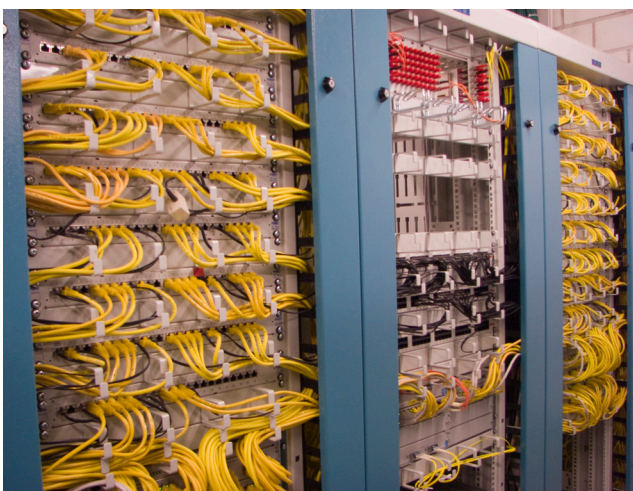



Newly arrived

Anke Teichert



What are you doing at the FRM II?

I am instrument scientist at PUMA.

What have you done before?

The last 9 years I worked at HZB in Berlin. I was the second instrument scientist at neutron reflectometer (V6) and I was responsible for polarized neutron reflectivity measurements (PNR). Focus

of my occupation was the optimization of neutron optical properties of polarized multilayer systems and characterization of magnetic thin films.

What are your special scientific interests?

Polarized neutron measurements, material science and magnetic materials.

Contact:

Phone: +49.(0)89.289.14756

Email: anke.teichert@frm2.tum.de

Oleg Sobolev



What are you doing at the FRM II?

I am co-instrument scientist at PUMA.

What have you done before?

I worked in Dubna (time-of-flight spectrometer DIN-2PI), in Berlin (triple-axis spectrometer FLEX) and in Grenoble (UJF, ILL, CNRS). In Grenoble, I studied hydration and sorption of radionuclides in clay minerals using neutron diffraction with isotopic substitution, QENS, EXAFS and MD simulations.

What are your special scientific interests?

Molecular dynamics in confined media, clay minerals, molecular liquids, inelastic and quasielastic neutron scattering, numerical simulations.

Contact:

Phone: +49.(0)89.289.14754

Email: oleg.sobolev@frm2.tum.de

FRM II's Blue Book:

Booklet „Experimental Facilities“ published

With the intention to inform users and those who want to become users, the FRM II published its new booklet dealing with the on-site experimental facilities.

The reader finds detailed information not only on the neutron source in general but also on the individual instruments arranged by measurement methods. Each instrument is described, examples of possible applications are given and the available sample environment is listed as well as the technical data. Furthermore a plan provides the reader with a detailed insight in the structure and dimensions of the instrument.

Curious? There are several ways to get hold of it:

- It is available online at www.frm2.tum.de/BlueBook
- It can be downloaded as .pdf from www.frm2.tum.de/en/user-office/downloads
- And finally a printed version can be ordered from the User Office: just write an email to userinfo@frm2.tum.de!



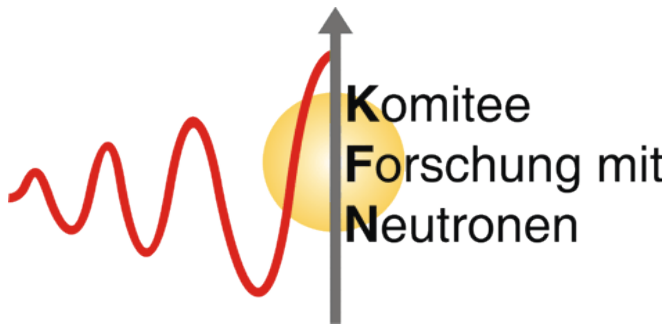

The editors of FRM II news are happy to present a page dedicated to the KFN for the first time. A special feed-back on this new content is welcome!

Dear readers,

the German Committee Research with Neutrons (KFN) represents the German neutron user community which is one of the largest and most lively neutron communities all over the world. It acts as an advisory body for funding agencies and helps to promote neutron science in close contact between Universities, Max-Planck- Institutes and Helmholtz-Research Centres.

The success of the new round of the BMBF-Verbundforschung has demonstrated impressively the capability of the German neutron science. In view of the final shut-down of the two neutron sources FRJ-2 in Jülich in May 2006 and recently the FRG-1 at Geesthacht in June 2010, the activities of German researchers are concentrated at the FRM II and BER II in Germany, at the ILL at Grenoble and, to a smaller extent, at the SNS at Oak Ridge. With the Jülich Centre of Neutron Science (JCNS) and the German Engineering Materials Science Centre (GEMS) at Geesthacht, new user access platforms have been created strengthening the co-operation between neutron facilities.

New perspectives will be opened by the European Spallation Source (ESS) that is going to be built at Lund, Sweden. Hence, there is a bright future for neutron science with novel applications and exciting experiments. It is of outmost importance for German neutron science that our community is significantly involved in the preparation, realisation and operation of this new flagship of neutron sources. Hence, KFN encourages and invites all users to contribute ideas for new science or new and innovative types of instruments. In the near future, a sequence of workshops on specific topics around ESS will be organised where those ideas and visions will be discussed.

Within the next year, KFN will publish a new strategy paper that describes the position of science with neutrons in Germany in view of the current and future available sources. It will describe the opportunities and the demands for the next decade.

KFN has started to inform the user community about new events by an E-mail newsletter. Obviously, we can only reach those people who are registered within our data base. In order to obtain a most accurate and comprehensive list of neutron users, there is a new user area on the KFN-website:

sni-portal.uni-kiel.de/kfn/user.php

Please have a look, whether you are already registered and check the correctness of the entries or create a new entry with your E-mail address and your user profile.

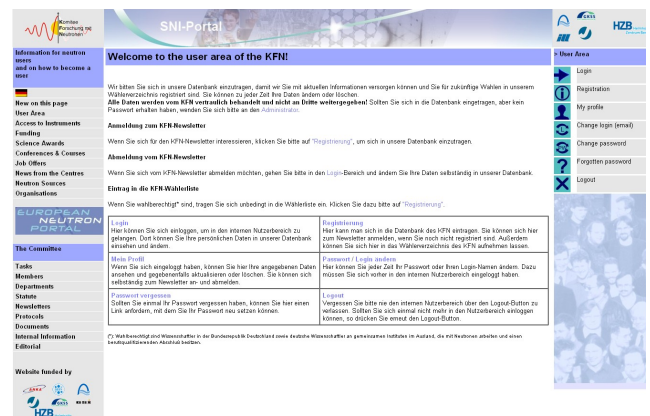

This user data base provides also the mailing list for the next election of the KFN that will take place in summer 2011. A large voter partition will strengthen the KFN and will help to represent the interests of neutron users. Hence, we would like to ask you to make sure that you receive the voting documents and use this opportunity to support our efforts for an efficient neutron infrastructure to the benefit of all users. Proposals for KFN-candidates can be submitted in written form to the chairman of the KFN and need the support of ten persons who are entitled to vote.



On behalf of the KFN, I wish you all a merry and peaceful Christmas time and a successful and healthy New Year.

Götz Eckold
Chairman of the 8th Committee Research with Neutrons (KFN)
(geckold@gwdg.de)

User development

The continuous flow of proposals requesting beam time at the FRM II reached a new peak with 621 proposals submitted to FRM II and JCNS at the two *Call for Proposals* in 2010. Even more important than this high request for neutrons was the number of more than 900 experiments with more than 4000 beam days scheduled at the 25 instruments in operation at the FRM II in 2010. These numbers were achieved despite the reduced number of reactor operation days of only 203 days due to the planned shut down of the FRM II on October 22nd in order to replace the positron source and to install future beam tubes in the reactor core. The reactor is planned to restart operation in March 2011. The long shut down unfortunately results in a reduced number of reactor days in 2011. 3.5 reactor cycles are planned to give 213 reactor days. The high number of proposals led to an overall overbooking factor at the available instruments of 2.8. Some instruments had to deal with overload factors around 4 resulting in a very strong competition for beam time. Therefore it was a hard task for the five scientific committees reviewing the submitted proposals. The majority of users are coming from German universities and research centers. Nevertheless more than 38 % of the proposals came from Europe and far abroad as China, India, Korea, Singapore, Australia, Brazil or the US. We hope the currently reduced number of available

beam days will have no severe effect on the number of submitted proposals. With new instruments coming into operation in 2011 as the protein crystallographic beam line BioDIFF, the third small angle neutron scattering instrument SANS-I, the reflectometer MARIA and the upgrade and up-date of existing instruments, new opportunities are available for future users and should attract scientists further on to use the FRM II.

Thomas Gutberlet, JCNS

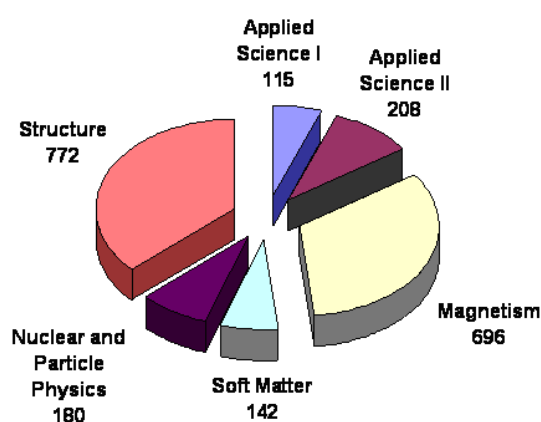

Figure 1: Beam time requested at the FRM II by scientific area in 2010, proposal round 12.

Call for proposals

Next deadline is May 6th, 2011

Proposals for beam time at instruments at the FRM II and at JCNS can be submitted within your own user account at any time to the digital user offices

user.frm2.tum.de

fzj.frm2.tum.de

The following instruments are available:

- **Diffraction**
BioDIFF, DNS, HEIDI, POLIHEIDI, RESI, SPODI, STRESS-SPEC
- **SANS/Reflectometry**
KWS-2, KWS-3, MARIA, MIRA, N-REX⁺, REFSANS
- **Spectroscopy**
J-NSE, PANDA, PUMA, RESEDA, SPHERES, TRISP, TOFTOF
- **Imaging**
ANTARES, NECTAR, PGAA
- **Positrons**
NEPOMUC

- **Particle physics**
MEPHISTO
- **Irradiation**
MEDAPP

Details on the instruments and sample environment available can be obtained at

www.frm2.tum.de/en/science/index.html

The review of the proposals will take place on June 17th, 2011. Results of the reviews will be online about two weeks later. The experiments of the accepted proposals will cover the reactor cycle 28 (August till September 2011) and cycle 29 (October till December 2011).

Please note that due to the refurbishment of the positron source at the FRM II the reactor will start only in March 2011. Unfortunately, this will slightly reduce the available beam time for experiments by 15 % in 2011.

FRM II user survey

After more than five years of user operation we took the effort to ask the users about their opinion regarding their use of the FRM II and things they like as well as dislike. This first FRM II user survey led to a great response by our users and we like to thank all of them for their help, answers, comments and criticism.

We were positively surprised about the majority of very positive reactions which is a great compliment in particular to the scientific staff of FRM II and the participating institutions.

Nearly 75 % of the users appreciated the option for access to unique scientific capabilities at FRM II and every second got benefit from the facilitated collaborative interactions. Also more than one third of the users claimed to benefit by education of students due to work at FRM II, which is of particular importance for the mission of the FRM II.

The vast majority of FRM II users are related to basic research. Nearly 20 % are within applied research, which is probably the highest number in this field at a neutron facility.

Nearly everyone planned to publish the results of the measurements in peer reviewed journals. Every second in addition wanted to present the work at conferences and workshops. 2 % of users planned to acquire a patent from the work done.

The most requested missing activity by the users is the absence of a guest house close to the FRM II. We cannot guarantee a quick answer to this request but the FRM II administration is well aware of this problem and is active to find a solution. Many users also are not satisfied with the procedure for clearance of samples and equipment by the radiation protection. We will discuss this and look for improvements. Many users also would appreciate announcements at the FRM II to be done in English. This is also a request we will tackle.

Thomas Gutberlet, JCNS

What further benefits did you gain at this facility?

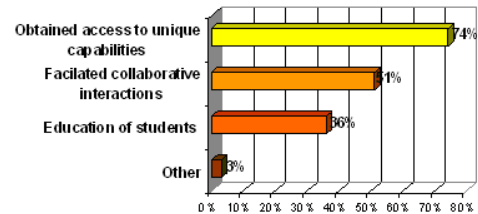

What was the subject of your use of this facility?

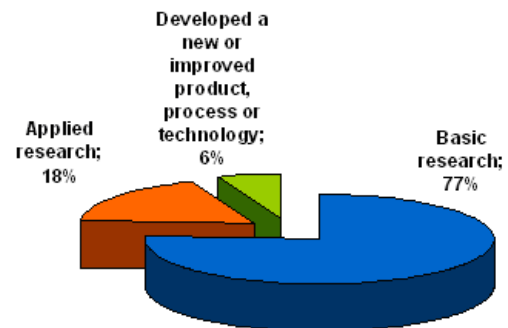

How do you intend on communicating the knowledge gained at this facility?

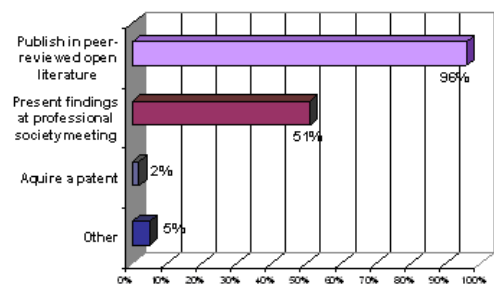

User Service

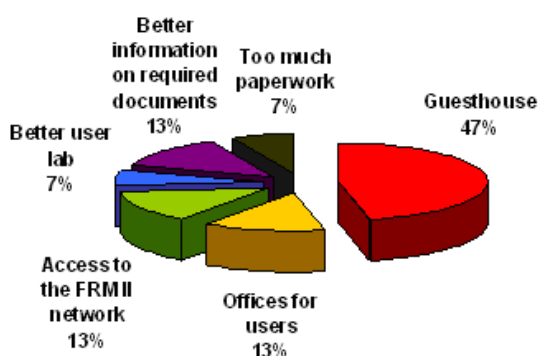

Radiation Protection

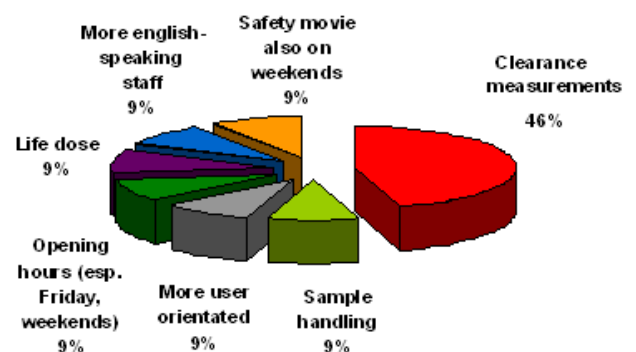



Upcoming

February 27-March 30, 2011

Hercules 2011 - Higher European Neutron Research Course for users of Large Experimental Systems (Grenoble, France)

hercules.grenoble.cnrs.fr/accueil.php?lang=en

March 13-18, 2011

75th Annual Meeting of the DPG and DPG Spring Meeting (Dresden, Germany)

(Dresden, Germany)

dresden11.dpg-tagungen.de/index.html?lang=en

Please note the tutorial "Physics with Neutrons" on March 13th with lectures of FRM II scientists.

March 28, 2011

Colloquium in the honour of the 100. anniversary of Heinz Maier-Leibnitz (Garching, Germany)

May 09-11, 2011

481. Wilhelm and Else Heraeus Seminar: Energy Materials Research by Neutrons and Synchrotron Radiation (Bad Honnef, Germany)

www.we-heraeus-stiftung.de/index.html

May 09-13, 2011

13th PFMC Workshop/ 1st FEMaS Conference (Rosenheim/ Germany)

www.femas-ca.eu/main/news_events_details.php?news_id=27

June 16, 2011

Colloquium in the honour of the 60. anniversary of Winfried Petry (Garching, Germany)

July 17.-21, 2011

5th European Conference on Neutron Scattering (Prague, Czech Republic)

www.ecns2011.org

September 5-16, 2011

15th JCNS Laboratory Course - Neutron Scattering (Jülich/ Garching, Germany)

www.jcns.info/wns_lab_now/

Deadline Proposal Round May 6th, 2011



user.frm2.tum.de

fzj.frm2.tum.de

IMPRINT

Editors

Thomas Gutberlet
Peter Link
Ina Lommatzsch
Jürgen Neuhaus
Andrea Voit

Picture Credits

A. Eckert/ A, Heddergott, TUM (12, 19,20), ESS (21), R. Gilles, FRM II (22), B. Gudehus, WIS (24f.), J. Herzen, TUM (14), F. Lipfert, JCNS (10), MRI, TUM (6), W. Schürmann (2, 17, 22), TUHH (23), U. Stiegel, FRM II (35).

If not indicated: By editors and/ or FRM II.

Contact

Technische Universität München
Forschungs-Neutronenquelle Heinz Maier-Leibnitz (FRM II)

User Office

Lichtenbergstraße 1

D-85747 Garching

Phone: +49.(0)89.289.10794 / 10703

Fax: +49.(0)89.289.10799

e-mail: userinfo@frm2.tum.de

www.frm2.tum.de

**Merry Christmas
and
a Happy New Year!**





**Ring out the old, ring in the new,
Ring, happy bells, across the snow:
The year is going, let him go;
Ring out the false, ring in the true.**

Alfred Lord Tennyson