

**Register now!**

**MLZ  
User Meeting**

**and**

**German  
Neutron Scattering  
Conference**

Munich: Dec. 8<sup>th</sup>-10<sup>th</sup>, 2020

**Newsletter**

**24**

MLZ is a cooperation between:

## The Heinz Maier-Leibnitz Zentrum (MLZ):

The Heinz Maier-Leibnitz Zentrum is a leading centre for cutting-edge research with neutrons and positrons. Operating as a user facility, the MLZ offers a unique suite of high-performance neutron scattering instruments. This cooperation involves the Technische Universität München, the Forschungszentrum Jülich and the Helmholtz-Zentrum Geesthacht. The MLZ is funded by the German Federal Ministry of Education and Research, together with the Bavarian State Ministry of Science and the Arts and the partners of the cooperation.

Bavarian State Ministry of  
Science and the Arts



SPONSORED BY THE



Federal Ministry  
of Education  
and Research



# Challenges and Chances

An editorial  
by

Having successfully completed our first cycle this year, the Corona pandemic has prevented the continuation of our user programme so far. Its impact on our users is of particular relevance, because the operation of our neutron source had already been hampered by the transport problems of fuel elements in 2019. Moreover, the successful operation of the Berlin reactor was stopped by the end of last year. Thus, by now, and for the near future, the provision of powerful neutron beams in Germany will solely rely on the operation of the FRM II. Since the provision of neutrons in Europe experience numerous challenges, all neutron centres agreed to work together even more closely in the framework of the LENS organisation. However, Covid-19 has affected all of us and delayed important research using neutrons in many places all around the world.

As an immediate measure to address access and travel restrictions which might last for quite some time, we have improved remote access opportunities and already accepted mail-in experiments from scientists working in Asia in the beginning of the year. For sure, remote or even mail-in experiments can not substitute personal cooperation and on-site working at instruments in all cases. Nevertheless, it will open up new opportunities for collaborations and also facilitate the use of our facility: For example, a part of an international proposal team adjusts experimental setups on-site and is able to discuss results as they come out of the detector online without any time delay with other team members all around the world. Presently, software support still needs some improvements, but we like to seize the opportunity to further develop our service. Any feedback from our users concerning this topic is appreciated very much!

For Corona research related experiments, we have established a special fast track service, so that proposals need not to go through the common MLZ proposal system. With this approach, we want to contribute to fight the Corona pandemic as soon as neutrons are back at FRM II.



**Peter Müller-Buschbaum**

*Scientific Director FRM II  
Scientific Director MLZ*

- 05 • 12 T magnet now available!
- 06 • Using TOF at KWS-2 SANS diffractometer
- 08 • Multimodal imaging using neutrons and gammas at NECTAR applied to ancient Roman concrete
- 09 • New polarizer for DNS

## INSTRUMENTATION

- 10 • A family gathering: MLZ User Meeting 2019
- 11 • New paths for archaeologists and geologists

## EVENTS

- 12 • A look inside dinosaur eggs
- 14 • RESEDA explained...
- 16 • Mg-ion conduction and dynamics in Mg(BH<sub>4</sub>)<sub>2</sub>-based materials

## SCIENCE & PROJECTS

- 18 • Astrid Schneidewind, Chair of the 11<sup>th</sup> KFN
- 24 • Adrian Rennie, Chair of the MLZ User Committee

## REMARKS

- 19 • Fuat Sezgin Award for PhD candidate at MLZ
- 20 • Newly arrived
- 23 • Two new directors for the FRM II

## INSIDE

- 25 • Some news from the User Office

## USER OFFICE



## 12 T magnet now in user operation!

Within the strategy of the Quantum Phenomena Science Group at MLZ, magnetism, superconductivity, and strongly correlated electrons have been identified as the focus of in-house research as well as user interests, driving the instrument development and sample environment requests. Therefore, the group suggested the purchase of two high-field magnets for diffraction and spectroscopy, respectively.

For diffraction experiments, an asymmetric 8 T diffraction magnet was purchased, which went into user operation in 2018. Many successful experiments were performed on different instruments since then, leading to several publications.

This year, the 12 T magnet for spectroscopy experiments became ready to operate. At the end of this year's first cycle, the 12 T magnet was installed at the PANDA cold TAS spectrometer for the first time, commencing user operation. After some starting difficulties and some technical constraints, which are unavoidable for such a complex sample environment, we managed to successfully perform five experiments with groups from Berlin, Munich, Aachen, and Dresden, studying for example magnetic excitations in orthoferrites.

The magnet is equipped with a VTI for temperature control and split-coils provide the magnetic field. The magnet is integrated in the NICOS instrument control software allowing an intuitive operation, making it possible to remotely control all field and temperature changes. The magnet offers a temperature range of 1.5 K to 300 K and a field range of -12 T to 12 T. It is worth to emphasize the extreme precision of the temperature control. Temperature steps as small as 0.02 K are possible, which allow for the investigation of excitations around magnetic and structural phase transitions in detail.

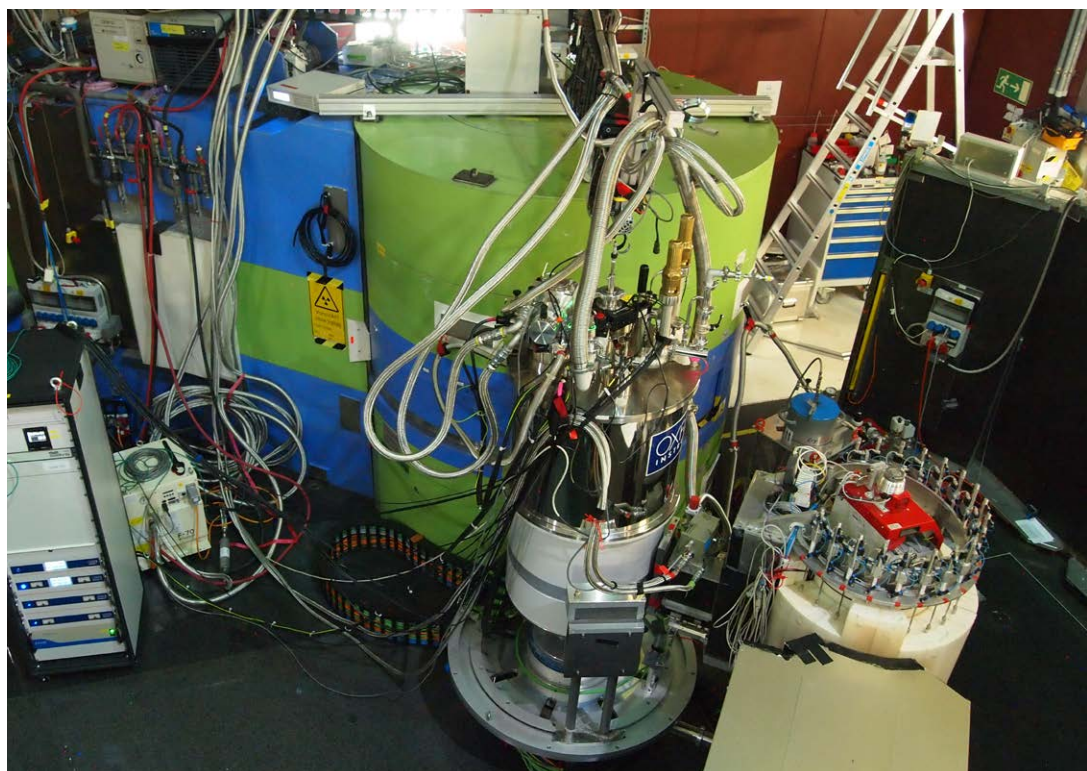

The new magnet, here at PANDA.

The magnet features a rather sizeable sample chamber with a diameter of 35 mm which allows quite large samples to be investigated, such as co-aligned crystal arrays or large samples of systems with weak magnetic moment. Furthermore, it is possible to use pressure cells or to insert fixtures to stabilize samples against torque exerted by large magnetic fields. A Helium re-condensing system reduces the Helium consumption as well as beamtime losses due to Helium re-filling.

Neutron scattering techniques are an essential tool in studying magnetic properties of materials. They contribute to the understanding of new phenomena such as unconventional ground states or functional materials and help gain a deeper insight in physical processes for new applications. Extending the sample environment suite of the MLZ by two magnets for diffraction and spectroscopy strengthens the role of the facility as a leading neutron facility, and satisfies the request of the scientific community for the opportunity of fundamental and applied research in magnetism with high magnetic fields.

*A. Schneidewind (JCNS)*

## Using TOF at KWS-2 SANS diffractometer: Improving the data quality in the high-Q regime towards WANS

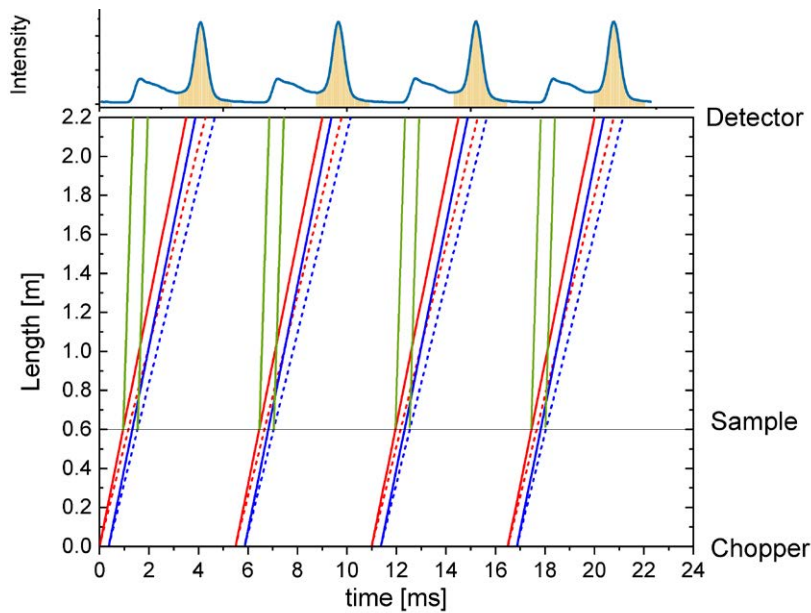

Fig. 1.

Taking advantage of the neutron contrast capability, the small angle neutron scattering (SANS) is able to resolve soft matter and biological hierarchical morphologies such as those developed by semi-crystalline polymers or proteins. In order to have a complete structural characterization of such multiple structural level morphologies, a wide-angle detection option is currently in planning at the KWS-2 high-intensity SANS instrument. Here, the ultimate goal is to enable measurements over a very wide Q-range between  $0.0002$  and  $2 \text{ \AA}^{-1}$ , by combining the very small angle scattering (via focussing geometry) with small and wide angle scattering (SANS and WANS, via pinhole geometry) methods at the same SANS diffractometer. With  $Q = 4 \pi \lambda \sin(\theta_s/2)$ , the modulus of the scattering vector  $Q$  (where  $\lambda$  is the incident neutron wavelength and  $\theta_s$  is the scattering angle), a  $Q_{\text{max}} = 2 \text{ \AA}^{-1}$  can be reached when neutrons with  $\lambda = 3 \text{ \AA}$  and a scattering range up to  $\theta_s = 60^\circ$  are used. This will enable to access the intramolecular and local length scale at short distances of several  $\text{\AA}$ , such as secondary protein structures or crystalline structures in semi-crystalline polymers.

At high  $Q$ , the coherent scattering that bears the structural information about the sample is typically much weaker than the  $Q$ -independent incoherent background. In the case of soft matter and biological samples, which to a large extent are hydrocarbon systems, the incoherent background contains a significant

amount of inelastic scattering that is not negligible, as usually considered in SANS. Inelastic scattering occurs at high  $Q$  values and adds to the scattering signal at small angles as a result of multiple scattering. In this case, the incoming monochromatic neutrons are thermalized in the sample and scattered with higher energies than the incoming (monochromatic) one, hence with shorter wavelengths. Moreover, for dilute systems, when single particle characteristics are to be determined, the high- $Q$  range is dominated by the nearly  $Q$ -independent scattering contribution from the solvent (buffer) or matrix, which exceeds by far the total scattering from the solute/ particles. Therefore, the knowledge about the sample background in the high- $Q$  SANS measurements, towards WANS, is very important for achieving high quality data.

Fig. 1 shows the time-distance diagram (lower panel) and the effect of using a single-disc compact chopper at KWS-2, which is placed in front of the sample, on the detection of the scattered neutrons by a  $1 \text{ mm}$  thick  $\text{H}_2\text{O}$  sample (upper panel). The chopper transforms the continuous incoming beam into a pulsed beam, emitting four pulses for each rotation. The use of TOF mode enabled to achieve a good separation of the elastically, quasi-elastically and inelastically scattered neutrons from the sample on the detector. The quasi-elastic line includes the broadening due to the wavelength distribution provided by the velocity selector ( $\Delta\lambda/\lambda = 10\%$ ), with the continuous and dotted lines indicating the fastest and the slowest neutrons.

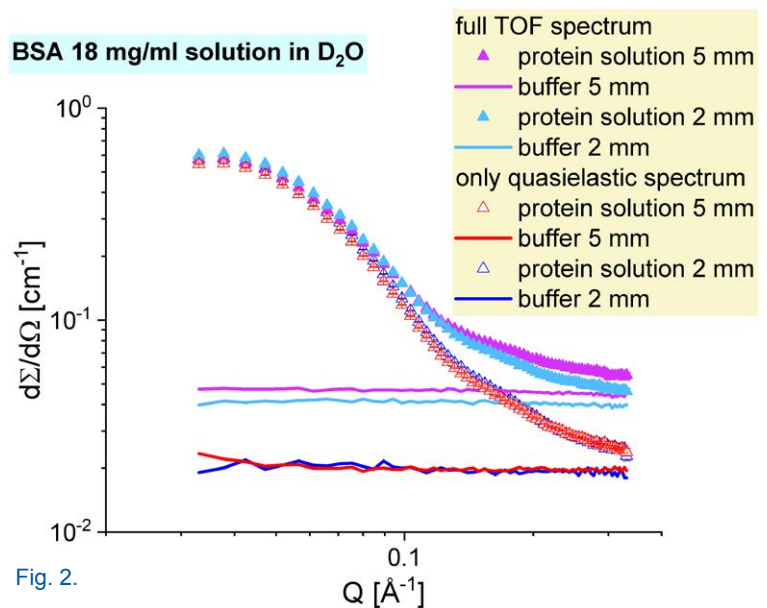

Fig. 2.



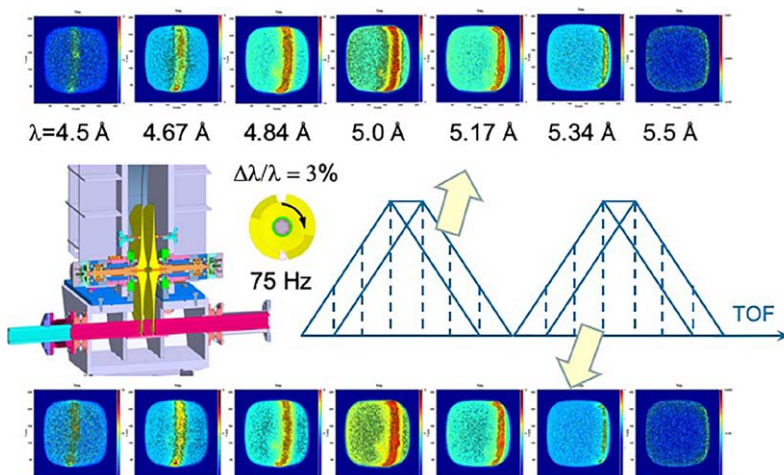

Fig. 3.

The red and the blue lines indicate the width of the neutron pulse provided by the chopper opening, which spreads in time on the way to the detector. Finally, the trajectories of the inelastically scattered neutrons with  $\theta_s = 1^\circ$  due to thermalisation in the sample are shown in green.

Using the time-stamped option of the detector, the pulses are summed together in the end of the measurement and one single TOF file is produced. When only the quasi-elastic scattered neutrons are considered for the data analysis (the orange domain in fig. 1, upper panel), a lower background level is obtained at high  $Q$  compared to the case when the whole spectrum is analyzed. Although the quasi-elastic data are still affected by some incoherent background from the sample, the results presented in fig. 2 on bovine serum albumin (BSA) in  $D_2O$  confirm that the inelastic scattering contribution, which depends on the sample thickness, adds up as an additional background that is visible towards high  $Q$  and is the higher the larger the sample thickness is. Unlike this, the quasi-elastic cross-section is the same for both considered sample geometries.

On the other hand, the quality of the scattering features in the high- $Q$  SANS regime, towards WANS, is affected by the broad wavelength spread  $10\% < \Delta\lambda/\lambda < 20\%$  that is typically used in SANS, due to intensity gain reason. This leads to smearing that can cause to a certain extent loss of the structural information contained in the SANS/ WANS data. This effect can be corrected by tuning the  $\Delta\lambda/\lambda$  with the main double-disc

chopper of the instrument, which is installed in front of the collimation system, and the TOF data acquisition on the future WANS detectors. Fig. 3 shows the working principle and the results obtained in a test carried out on a C60 fullerene sample that shows a first crystalline peak at  $Q^* = 0.77 \text{ \AA}^{-1}$ . The experiment was set up to collect in TOF mode the scattered neutrons at  $\theta_s = 35^\circ$ , well above the upper limit of the typical angular range used in SANS, on a high-resolution scintillation detector (HRD) placed at about 20 cm after the sample. This permitted to split the two broad pulses delivered by the chopper, which are characterized by a wavelength resolution delivered by the velocity selector, into several TOF channels with much narrower resolution ( $\approx 3\%$ ) and to clearly observe the crystalline peak from the sample. The effect of the wavelength spread on the quality of SANS/ WANS data is shown in fig. 4, where the one-dimensional and two-dimensional scattering patterns from the C60 fullerene sample are shown as they were collected for different  $\lambda$ ,  $\Delta\lambda/\lambda$  and angular range conditions.

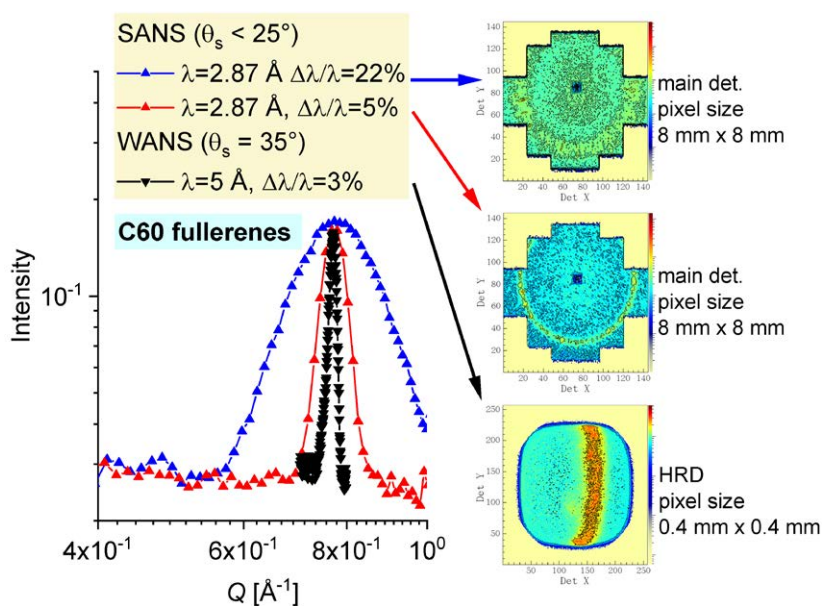

Fig. 4.

With the newly designed WANS option that will enable the detection of neutrons scattered up to an angle of  $\theta_s = 60^\circ$ , using the TOF mode at KWS-2 will allow for a more accurate measurement of weak coherent signals from small proteins in solution or semi-crystalline polymer structures.

A. Radulescu (JCNS)

## Multimodal imaging using neutrons and gammas at NECTAR applied to ancient Roman concrete

NECTAR is a unique beamline with access to fission neutrons for non-destructive inspection of large and dense objects, where thermal neutrons or X-rays face limitations due to their comparatively low penetration. With the production of fission neutrons at the instrument, gamma rays are produced in the same process. The production of these gamma rays is inevitable as they are inherent with the production of fission neutrons and the principles of collimating or stopping them. Furthermore, the gamma rays are highly directional due to their constraint to the same beamline geometry and come with similar divergence as the neutrons. While difficult to shield, it is possible to utilize them by using gamma sensitive scintillator screens in place of the neutron scintillators viewed by the same camera, enabling multimodal imaging using thermal and fast neutrons, as well as gammas at the NECTAR instrument.

The first measurements utilizing this technique were performed in spring of 2020 on ancient Roman concrete specimens. The pozzolanic concretes of the

monuments of ancient Rome and the seawater harbor constructions that Romans built in the Mediterranean Sea are some of the most durable cementitious materials on the planet. They remain resistant to decay, even after 2000 years exposure to groundwater saturation, strong variations in relative humidity, and submersion in seawater. Modern production of Portland cement is an energy intensive process responsible for a staggering 5-8 % of the annual global CO<sub>2</sub> emissions. The concretes of ancient Roman monuments and seawater harbors, produced from volcanic rocks and hydrated lime, have a far smaller CO<sub>2</sub> footprint than conventional Portland cement concretes, far greater chemical and mechanical resistance to decay, and a smaller energy budget to produce.

The goal of this investigation is to gain a fundamental understanding of the cracking mechanism of ancient Roman concrete: the interaction of large lightweight rocks with the matrix and the pozzolanic reaction between calcium hydroxide and amorphous alumino-silicate that the Roman engineers used. The measurements at NECTAR provide information complementary to other non-destructive studies conducted with X-rays and Scanning Electron Microscopy, with the possibility to visualize and to quantify water distributions. Furthermore, the dual modality provided by neutrons and gammas adds elemental sensitivity on cm length scales, not accessible with other techniques. With the recent upgrades at NECTAR, both modalities can be measured combined. The insight gained by these measurements is crucial in developing a new generation of high-performance concrete that may last centuries.

The measurements at NECTAR provide information complementary to other non-destructive studies conducted with X-rays and Scanning Electron Microscopy, with the possibility to visualize and to quantify water distributions. Furthermore, the dual modality provided by neutrons and gammas adds elemental sensitivity on cm length scales, not accessible with other techniques. With the recent upgrades at NECTAR, both modalities can be measured combined. The insight gained by these measurements is crucial in developing a new generation of high-performance concrete that may last centuries.

*A. Losko, M. Schulz, R. Schütz (FRM II);*

*A. Tremsin, Paulo J.M. Monteiro, K. Xu, J. Li (UC-Berkeley)*

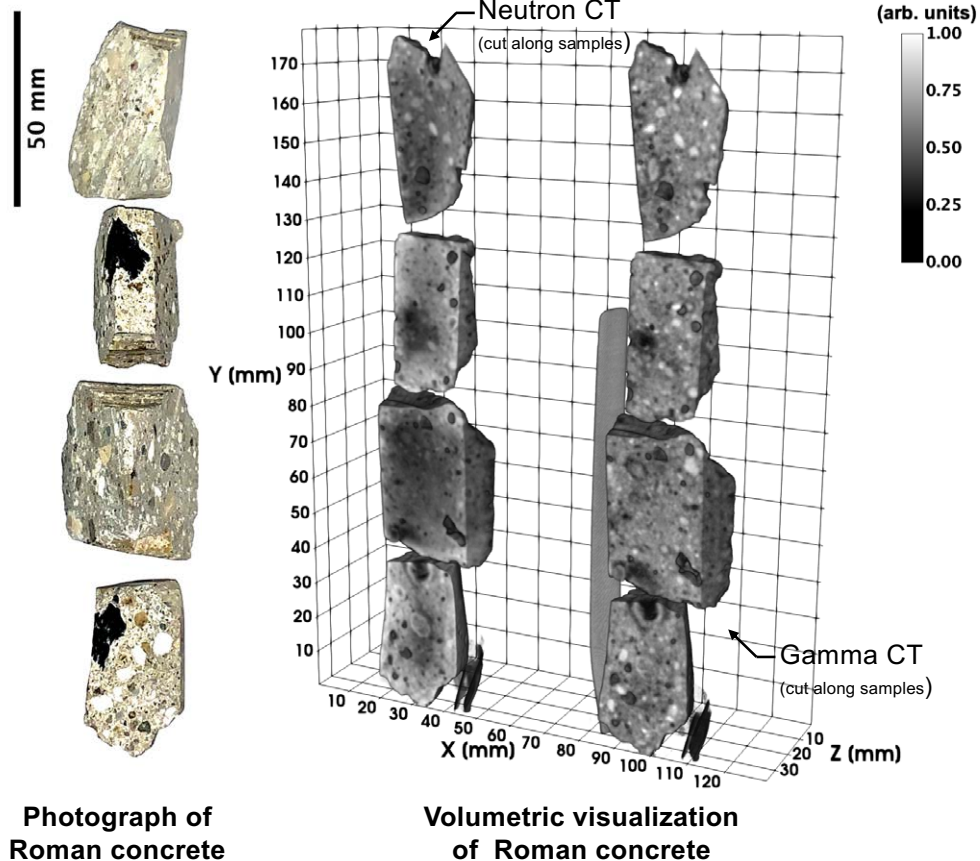

Photograph of Roman concrete

Volumetric visualization of Roman concrete

Photograph of Roman concrete specimens on the left. Volumetric reconstruction of the specimens using simultaneously recorded neutron and gamma CT on the right. The two modalities show different contrast of the various features within the concrete samples.



## New polarizer for DNS

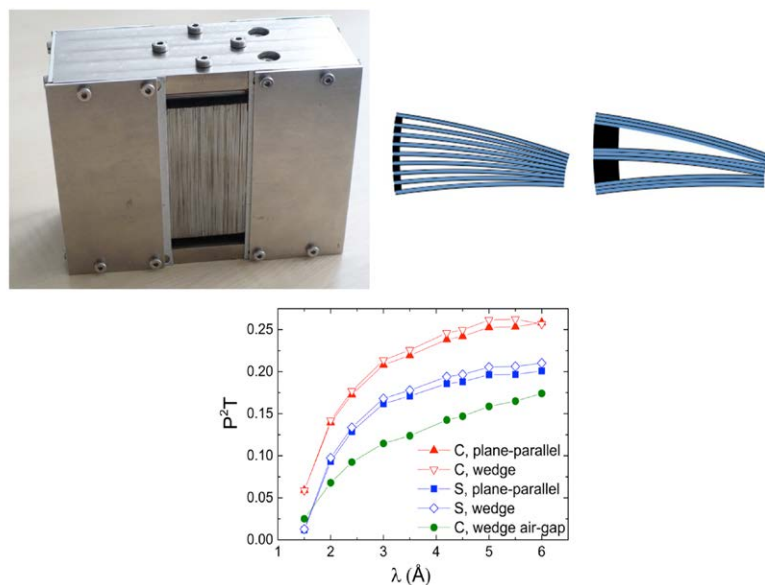

Fig. 1: The new DNS polarizer and its estimated performance.

As a planned major instrument upgrade, the installation and subsequent commissioning of a new generation Fe/Si solid-state focussing polarizing bender have been accomplished at DNS recently. The previously used polarizer is a Schärpf-type bender with a length of 29 cm using the polarizing FeCoV/Ti:N supermirror coating. The strong neutron activation of this polarizer had caused considerable problems over the years. Furthermore, due to the recent upgrade of the neutron guide NL6 from  $m = 1.2$  to  $m = 2$ , a considerable gain in neutron flux for the short-wavelength range is achieved for DNS. These are among our main considerations for the design and construction of a new generation polarizing device that is compact, and has no issues with strong neutron activation, and would also bring considerable performance gain for short-wavelength neutrons. Our concept for this is based on the idea of a solid-state bender composed of a number of silicon wafers with a double-sided Fe/Si polarizing supermirror coating separated by the absorbing spacers. With this approach, one can design a very compact polarizing device, which would allow more space for other instrument components such as a chopper system.

After extensive VITESS simulations of the bender parameters by the DNS team, a solid-state  $m = 3$  supermirror Fe/Si focusing C-bender (see fig. 1), which has a length of only 64 mm, contains 255 silicon wafers,

and includes plane-parallel channels with spacers at the entrance between each channel, had been chosen for production. In addition to the new polarizer, a new motorized manipulation stage that allows the X-Y-Z translation as well as the rotation of the polarizer has been developed. The magnetic guide field and a robust radiation shielding have been seamlessly integrated with this stage (see fig. 2). The preliminary results obtained from our recent commissioning experiments have indicated that the performance of the new polarizer at the selected neutron wavelength is consistent to that estimated from our design, with roughly 50 % increased polarized flux at the sample position largely due to an optimal focussing. The very good performance of the new polarizer manipulation stage as well as its integrated guide field and radiation shielding has also been thoroughly demonstrated. While further tests are still needed once neutrons are back at FRM II, we believe that a considerable performance gain for a wide range of polarized neutron

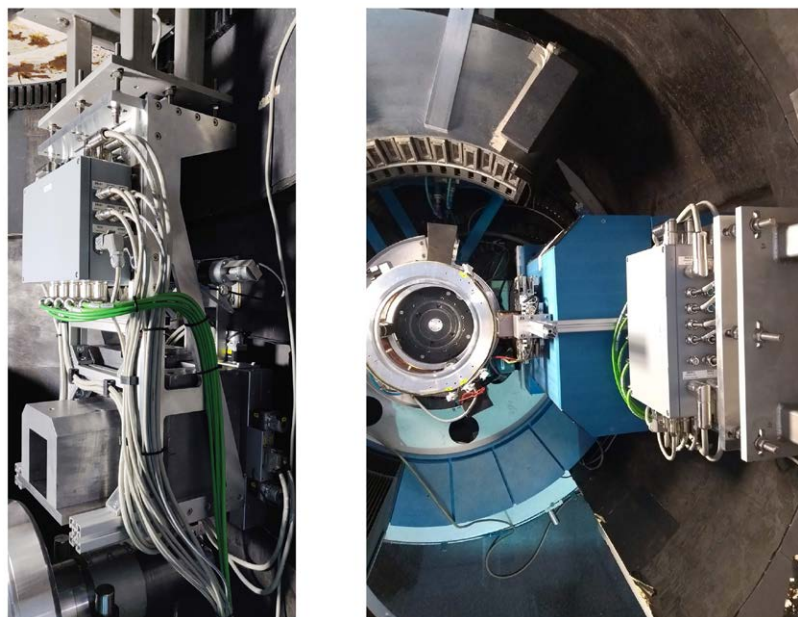

Fig. 2: The new polarizer manipulation stage with the integrated magnetic guide field and radiation shielding.

scattering experiments can be achieved at DNS. Last but not least, without strong and professional supports from our local technical teams, instrument control and software groups, and the JCNS and central technical departments in Forschungszentrum Jülich, it would have not been possible for the successful installation and commissioning of this wonderful new instrument component for DNS.

*Y. Su, T. Müller (JCNS)*

## A family gathering: MLZ User Meeting 2019



On December 10<sup>th</sup>/11<sup>th</sup>, the MLZ User Meeting took place. After a break of several years, we started with a fresh format and the plan to invite our users from now on on a yearly base to exchange ideas, get and give feedback, discuss results, and just be part of the MLZ user community.

The first day was dedicated to the workshops organised by our Science Groups. It was not easy to decide where to go and listen: A total of seven parallel sessions tempted the 243 participants. They dealt with Materials Science, Soft Matter, Structure Research, Quantum Phenomena, Neutron Methods, Nuclear, Particle and Astrophysics, and Positrons. All sessions were visited well and during the coffee breaks, discussions went further.

In the evening, everybody enjoyed the Bavarian dinner at the Franziskaner opposite the famous Munich Residence, the seat of government and residence of the Bavarian dukes, electors and kings from 1508 to 1918.

The second day back at the Marriott Hotel in the north of Munich, started with a welcome by the MLZ Director and spokesman Peter Müller-Buschbaum. He provided detailed information on the future plans at MLZ and answered the users' questions.

The first plenary talk "Inner Structure and Dynamics of polymers at interfaces" by Regine von Klitzing (Universität Darmstadt) addressed two different types of thin polymer films at interfaces: those formed by dep-

osition of hydrogel microgels and those by polymer brushes and their dynamics were studied under grazing incidence.

In the second plenary talk, Bella Lake (Helmholtz-Zentrum Berlin) gave an overview on quantum magnetism. It studies the behaviour of magnetic materials where quantum fluctuations are strong and give rise to exotic behaviours not found in conventional magnets.

With the last talk, Francesco Grazzi (CNR-IFAC) took the listeners back to the past: Neutron tomography helped him to get deeper insights into the metal preparation and forging processes of ancient Indian blades made from wootz steel also known as "Damascus steel".

After lunch, 100 posters at the poster session showed the broad range of science with neutrons and positrons. Then, many users also took the opportunity to visit the dedicated booths of Scientific Computing and Instrument control software as well as the GhOST Welcome Centre. With the User Meeting, the new online software of the User Office went online and the GhOST team was happy to show the features of this new system that had been developed over a few years.

We received a lot of positive feedback at this User Meeting and are looking forward to the next one this year: Due to the uncertain times, it will be a really special one!

*I. Lommatzsch (JCNS)*



## New paths for archaeologists and geologists

The Heinz Maier-Leibnitz Zentrum (MLZ) opens new research opportunities for scientists from a wide range of disciplines. But who knows and uses the manifold possibilities of neutron research?

Exactly for this reason the MLZ has launched the joint project “New Imaging with Neutron and X-ray Methods for Archaeology and Cultural Heritage” (NINXMACH) in cooperation with the newly founded Lund Institute of Advanced Neutron and X-Ray Science at Lund University in Sweden (LINXS). It is a new initiative, which offers “try-out workshops” especially for researchers in the fields of cultural heritage and geology to demonstrate the manifold possibilities of using X-rays and neutrons.

Two workshops were available: One in February at the Synchrotron ELETTRA in Trieste and one in March at the MLZ in Garching. Researchers could participate in both to gain experience with X-rays as well as with neutrons. In the future, the knowledge, exchange, and expertise gained by the scientists should bring also further users to the planned European Spallation Source for Neutron Research (ESS) in Lund.

In total, eleven participants were able to measure their own samples at three different instruments at the MLZ. They came to know imaging techniques at the instrument ANTARES with cold neutrons and at NECTAR with thermal neutrons. An elemental analysis was possible via the prompt gamma activation analysis at the instrument PGAA.

Björn Nilsson, archaeologist at the University of Lund, participated, too. He brought a possible Roman figurine and a knife from the Iron Age and examined it on all three instruments. Nilsson is looking for clues about the materials used and the manufacturing process. “The data show the structure of the knife and how it is made of different carbides, with a softer cutting edge and a harder blade. With neutrons we can answer questions we didn’t even know we could ask,” he says. “I definitely plan to come back and examine more samples.”

Burkhard Schillinger, instrument scientist at MLZ, organized and supervised the workshop at MLZ. “The Federal Institute for Materials Testing in Berlin has already asked for such a workshop,” says Schillinger proudly.

*G. Mantzaridis (FRM II)*





## A look inside dinosaur eggs

Did oviraptorid chicks hatch like birds or alligators? Researchers at the University of Bonn and the Technical University of Munich provide presumptive evidence with the help of neutron tomography.

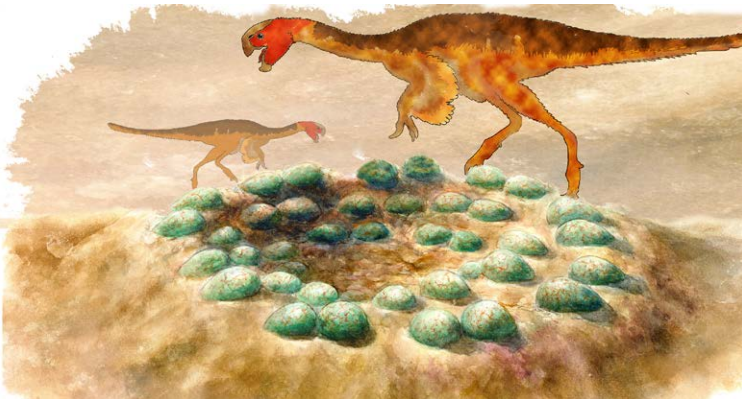

© C.-H. Lee/ T.-R. Yang/ T. Engler

Reconstruction of a clutch of eggs of oviraptorids.

Did the chicks of dinosaurs from the group oviraptorid hatch from their eggs at the same time? This question can be answered by the length and arrangement of the embryo's bones, which provide information about the stage of development. But how do you look inside fossilized dinosaur eggs? Paleontologists from the University of Bonn used neutrons at the MLZ. Tomographic pictures from ANTARES and NECTAR showed that oviraptorids developed at different speeds in their eggs and that they resemble modern birds in this respect. The results have been published in the journal "Integrative Organismal Biology".

Until now, researchers have assumed that the two-legged dinosaurs known as oviraptorids, which lived in Central Asia during the Upper Cretaceous (from 88 to 66 million years), should be placed between modern crocodiles and birds with regard to their reproductive biology. Crocodiles bury their eggs and the offspring hatch at the same time. With birds, however, hatching in the nest often happens at different times.

### Read more

T.-R. Yang et al,  
Integrative Organismal Biology,  
Volume 1, Issue 1, 2019, obz030

DOI: 10.1093/iob/obz030

Together with scientists from Taiwan, Switzerland, and the MLZ, paleontologists from the University of Bonn have now investigated how differently the development of embryos in three 67 mil-

lion years old oviraptorid egg fossils from the Ganzhou Basin of Jiangxi Province in China had progressed. "Oviraptorid eggs are found relatively frequently in Central Asia, but most of them are removed from the context of their discovery," says Thomas Engler from the Institute for Geosciences at the University of Bonn. Often it is then no longer discernible whether the eggs are from a single clutch.

"This is different with the fossils we've examined: We found a pair of eggs and another egg together embedded in a block of rock," reports Tzu-Ruei Yang, who discovered the unusual find during an excavation near the city of Ganzhou in China. This led the researchers to conclude that the 7-inch (18 cm) eggs were laid almost at the same time by a female oviraptorid. Yang completed his doctorate at the Institute for Geosciences at the University of Bonn and now works as a researcher at the National Museum of Natural Sciences in Taiwan.



Preparing the eggs for the measurements.

The researchers tried to estimate whether the baby dinosaurs would have hatched at the same time or at different times based on the developmental stage of the embryos in the three eggs. The length of the bones in the egg plays an important role here. "The embryo with comparatively longer bones is more developed," explains Yang. Another indication is the extent to which the bones are connected to each other. A more strongly connected skeleton suggests a higher developmental stage of the dinosaur embryo.

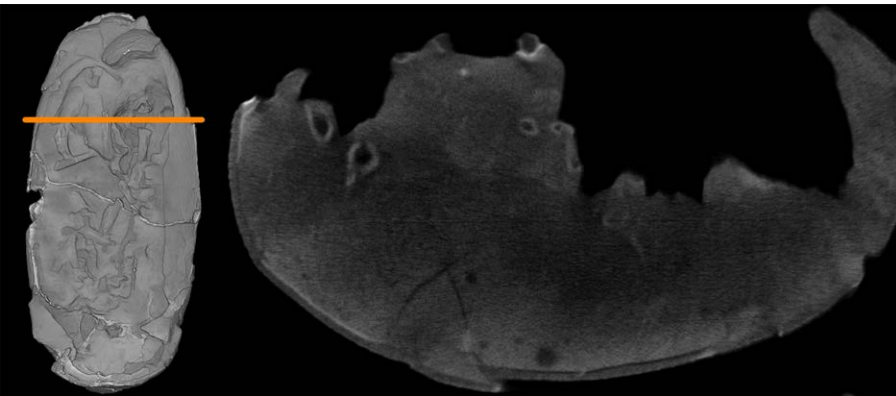

One of the eggs at ANTARES (left) and at NECTAR (right).

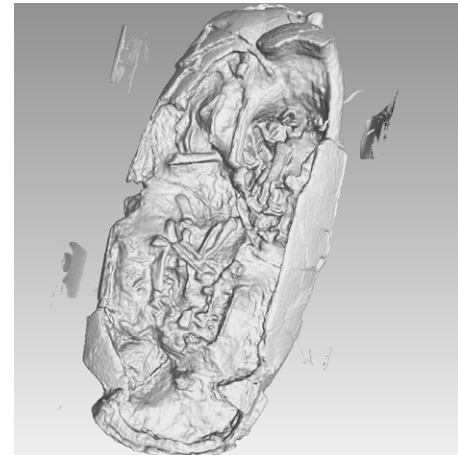

But how is it possible to determine the position of bones inside a fossilized dinosaur egg? The paleontologists at the University of Bonn initially tried to do this with the institute's own X-ray microcomputer tomograph. "Unfortunately, it was not possible to distinguish the bones from the surrounding rock," says Engler. For this reason, the researchers took the dinosaur eggs to the research neutron source in Garching. "The high penetration depth of the neutrons at the NECTAR and ANTARES facilities made it possible to visualize the internal structures," says Malgorzata Makowska, who was in charge of measurements and analyses at the MLZ and is now carrying out research at the Paul Scherrer Institute in Switzerland.

The length and position of the embryo bones led the researchers to conclude that the single egg must have been laid earlier than the pair of eggs in the same clutch. However, the embryos of the pair were also at different developmental stages. Thin sections confirm

these results. The researchers used these to measure the thickness of the eggshells. The developing embryo absorbs part of the shell because it needs calcium for its growing skeleton. "The more material is removed from the egg shell, the more advanced the embryo's development," explains Yang.

On the basis of these indications, the scientists conclude that the reproductive biology of oviraptorids were similar to that of modern birds, whose chicks hatch at different times. The results argue against the strategy of crocodiles or turtles, which all emerge from their eggs at the same time. This has brought the researchers one step closer to the life of the long extinct oviraptorids, who roamed Central Asia on two legs. "Furthermore, the study shows that exploring fossils with neutrons yields novel scientific results," says Engler.

*J. Seiler (Universität Bonn)*



Photogrammetry of „egg 3“. The object was photographed and reconstructed from different perspectives.

© J. Lallensack



# RESEDA EXPLAINED USING THE T

BOX THAT PICKS THE  
TINY THINGS ON HOW  
FAST THEY GO

THINGS THAT FLIP  
THE DIRECTION OF  
THE TINY THINGS

THINGS THAT MAKE SURE  
THE TINY THINGS DON'T  
LOSE THEIR DIRECTION

BOX THAT CH  
THE DIRECTIO  
TINY THINGS

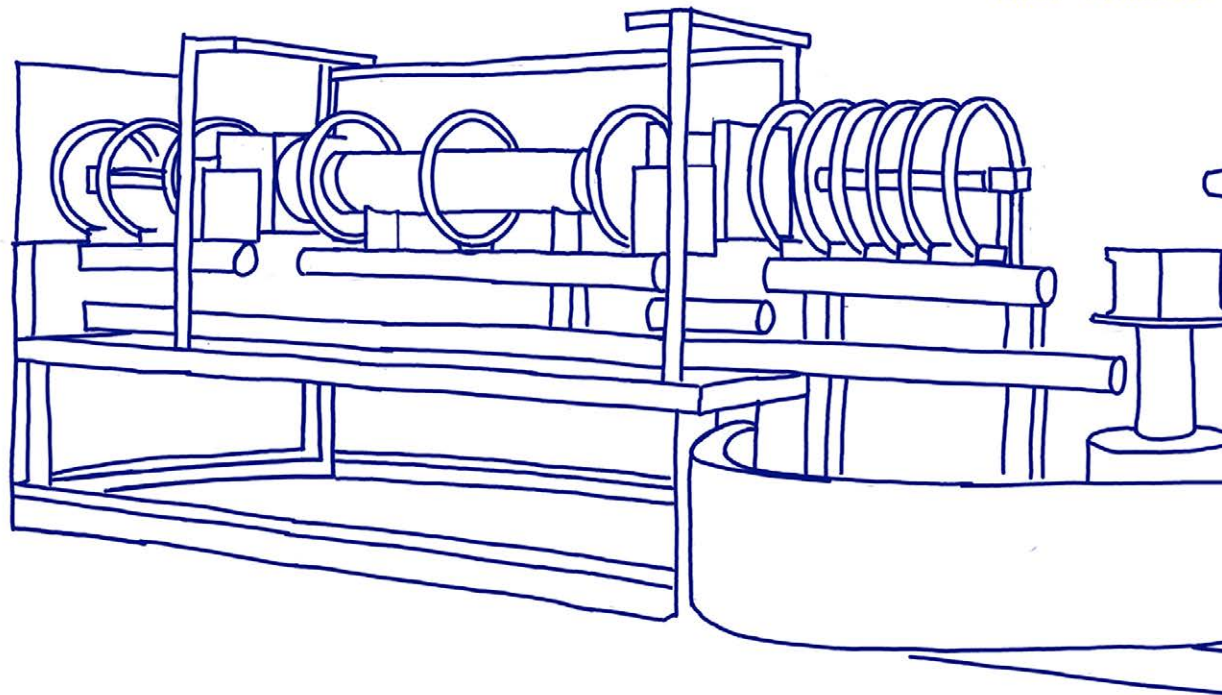

Johanna Jochum, instrument scientist at RESEDA, posted this beautiful drawing on her Twitter account. We asked her for the story behind it!

*The “ten hundred words” challenge started with an xkcd comic strip describing the “Up goer five”, a detailed sketch of the Saturn V moon rocket using only the 1000 most used words in the English language. The word “thousand” is not one of those words. I thought this was a fun way of trying to make complicated topics more accessible to the general public, so I decided to describe RESEDA using just the “ten hundred” most used words.*



# TEN HUNDRED MOST USED WORDS

CHECKS  
ON OF THE

POSITION OF THINGS  
WE WANT TO STUDY

AIR FREE BOX

PICTURE  
TAKING BOX

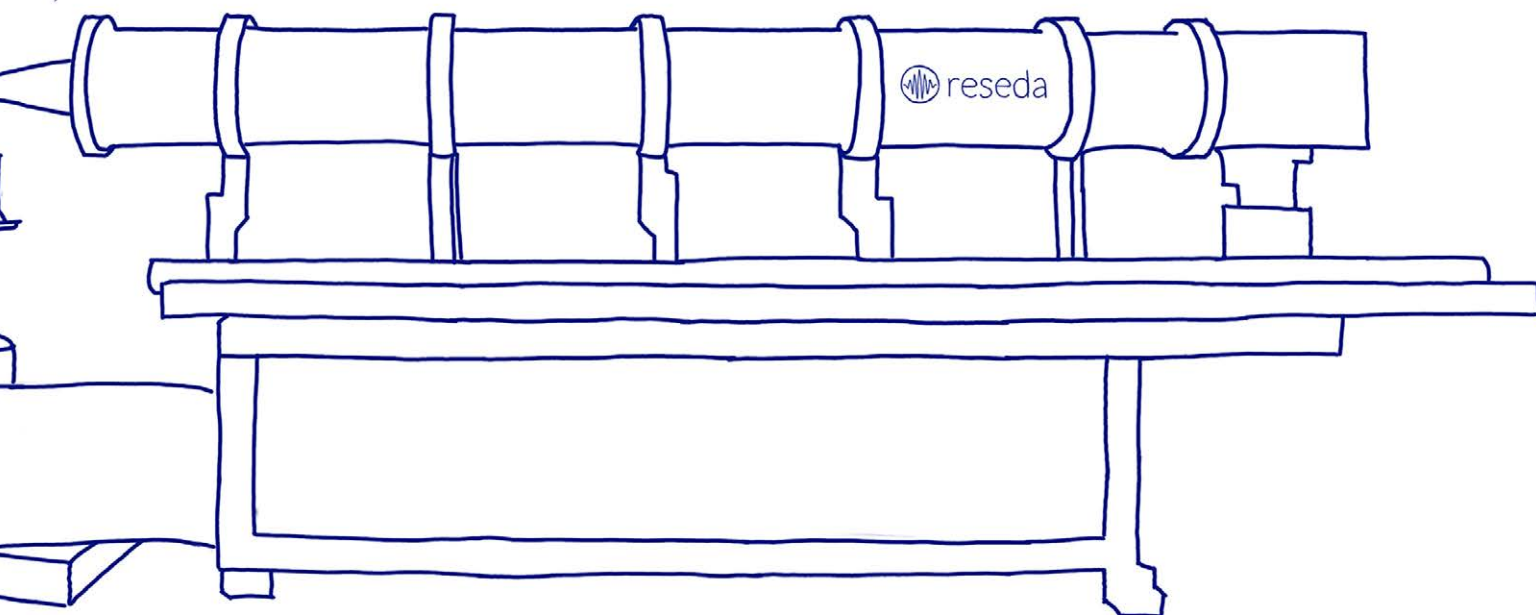

## Also thrilled?

Find *Up goer five* at  
<https://xkcd.com/1133/>

Find another challenge by HZB  
<https://science.hzbblog.de/ten-hundred-words-challenge>

## Mg-ion conduction and dynamics in $\text{Mg}(\text{BH}_4)_2$ -based materials

Problems with Li-ion batteries have been a yearly re-occurring item, such as the South-Korean branded smartphone, which was banned from flights a couple of years ago or the battery car which was responsible for whole park decks burning down in Norway. What is so hazardous in those Li-ion batteries is the so-called electrolyte, a flammable liquid contained in every Li-ion battery. The electrolyte consists of a lithium salt, such as  $\text{LiPF}_6$ , dissolved in an organic solvent. The salt inside the electrolyte is responsible for the transport of Li-ions from the graphite-anode to the cathode, releasing the energy required to power e.g. your smartphone, laptop or electric car. Therefore, there is a considerable interest in developing all-solid-state batteries, where the liquid electrolyte is replaced with a non-volatile solid material. As a benefit, aside from increasing the safety of battery-containing devices, this could lead to dramatically increased energy densities and much smaller, lighter batteries.

Materials considered for all-solid-state batteries (ASSBs) include, but are not limited to,  $\text{Na}^+$ ,  $\text{Mg}^{2+}$  and  $\text{Ca}^{2+}$ -based compounds, while this short article aims to review the dynamics of the ionic conduction process in a complex metal hydride, containing magnesium (Mg), boron (B) and hydrogen (H), while other chemistries for operation in ASSBs are discussed elsewhere.[1,2]

The category of solid-state Mg-ion conductors was immensely accelerated by Roedern et al. They reported a new compound,  $\text{Mg}(\text{en})_{1.0}(\text{BH}_4)_2$  synthesised from  $\text{Mg}(\text{BH}_4)_2$  and ethylenediamine ( $\text{C}_2\text{H}_8\text{N}_2$ , 'en') and claimed a Mg-ion conductivity of  $\sigma = 6 \cdot 10^{-5} \text{ S} \cdot \text{cm}^{-1}$  at 343 K.[3] The synthesis process was based on ball milling and thermal treatment, and it was reported that an amorphous phase, possibly amorphous  $\text{Mg}(\text{BH}_4)_2$ , is beneficial for the conductivity. Therefore, it seemed helpful to investigate the influence of this

amorphous  $\text{Mg}(\text{BH}_4)_2$  on the conduction process and the results have been published recently.[4]

The quasi-elastic neutron scattering (QENS) data depicted as the scattering function  $S(Q, \Delta E)$  in fig. 1. These data were used to explore the differences in internal dynamics between crystalline  $\gamma$ - $\text{Mg}(\text{BH}_4)_2$  (red circles) and amorphous  $\text{Mg}(\text{BH}_4)_2$  (green squares) at 310 K. The data in fig. 1 show that the quasi-elastic and the inelastic contribution are strongly reliant on the local structure. The  $\gamma$ -phase exhibits hardly any stochastic motion or quasi-elastic contribution around the elastic line at an energy transfer  $\Delta E = 0 \text{ meV}$ . In contrast, the amorphous phase reveals a significant broadening around this elastic line, which is indicative of higher rotational mobility of the  $[\text{BH}_4]$  moieties. [4]

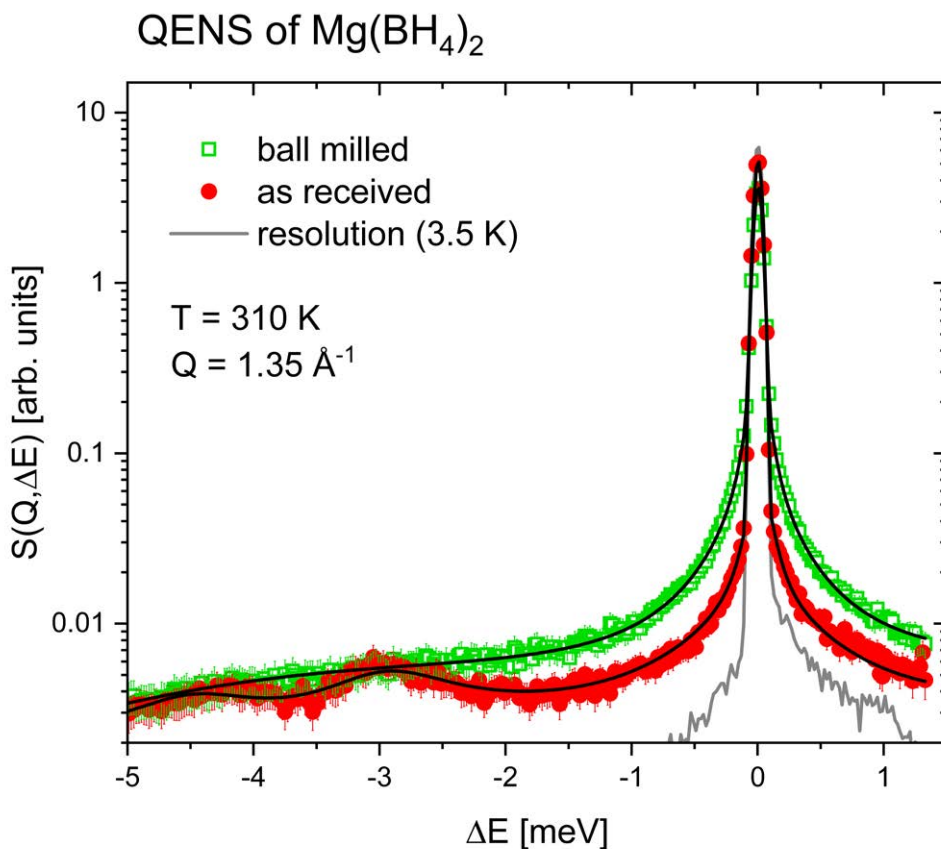

Fig. 1: Quasi-elastic neutron scattering (QENS) studies of  $\text{Mg}(\text{BH}_4)_2$  in crystalline  $\gamma$ -modification (red circles), and amorphous modification (green squares). The solid black curves represent the fit to the TOFTOF data.

Electrochemical impedance spectroscopy (EIS) data was employed to investigate the temperature dependent conductivity of both samples. At 80°C, amorphous

## Mg-ion conductivity increases via ball milling

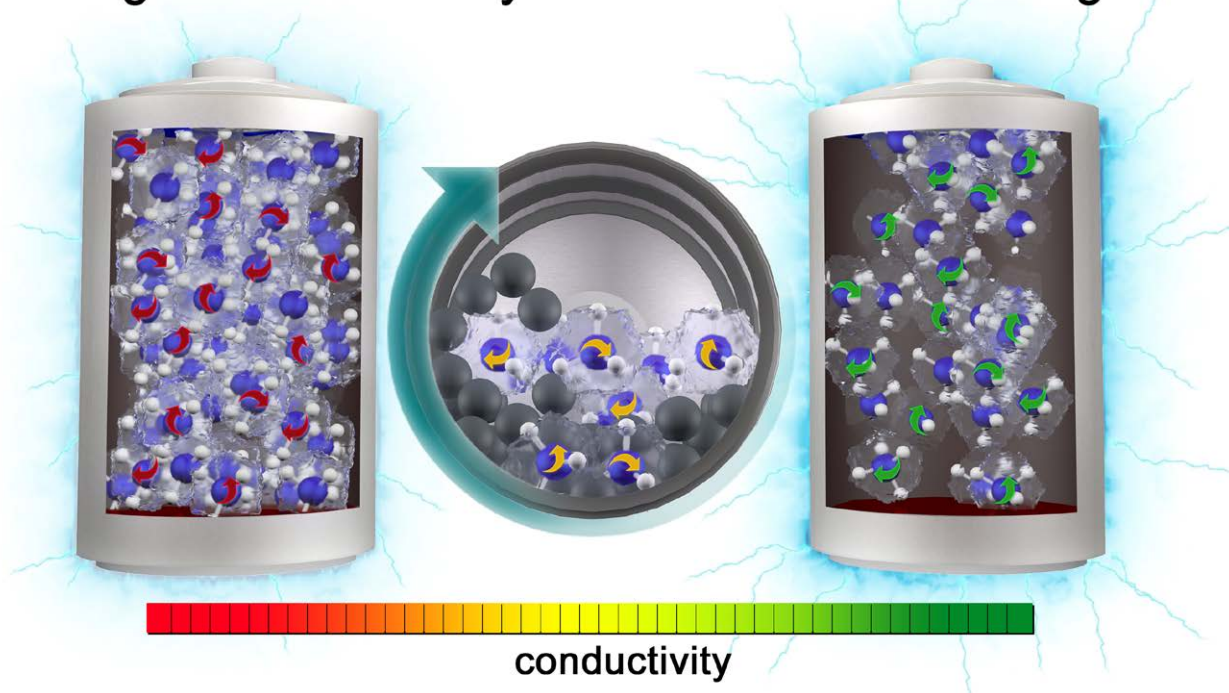

Fig. 2: This representative sketch is showing the  $[\text{BH}_4]$  tetrahedra without their respective Mg setting. The intention is to visually show that the conductivity in as-received material (left) is low and increases via Ball milling due to the higher rotation of the  $[\text{BH}_4]$  tetrahedral.

$\text{Mg}(\text{BH}_4)_2$  has an almost two orders of magnitude higher conductivity compared to  $\gamma\text{-Mg}(\text{BH}_4)_2$ . From the analysis of pair distribution function (PDF), we already knew, that both samples consist of similar structural local building blocks. Therefore, we suggested that also the conduction pathway might be similar. A deeper analysis of the QENS measurements showed that the number of activated  $[\text{BH}_4]$  rotation was considerably higher in amorphous  $\text{Mg}(\text{BH}_4)_2$  (see fig. 2). Combined with the suggestion of a similar conduction pathway, it seemed obvious that these rotations support the Mg-ions movement. This effect was suggested to be the paddle wheel mechanism. Our findings are supported by the following observation: when the paddle wheel mechanism stops at the crystallization temperature (i.e. the rotating  $[\text{BH}_4]$  become inactive) the conductivity drops to the same level as crystalline  $\gamma\text{-Mg}(\text{BH}_4)_2$ . [4] An overview of structure and dynamic investigations in borohydrides by neutron scattering techniques can be found in [5].

When compared to the alkali metal borohydrides, two points are worth mentioned. Firstly, opposed to the alkali metal borohydrides, no order-disorder transition was reported for the alkaline-earth borohydrides. Especially in  $\text{LiBH}_4$ , this order-disorder transition is connected to the superior  $\text{Li}^+$  conductivity and especially the reorientational freedom of the  $[\text{BH}_4]$  units. Secondly, in agreement to the findings for alkali metal borohydrides, enhanced metal-ion conduction, here of the Mg-ion cations, has been shown experimentally in  $\text{Mg}(\text{BH}_4)_2$  based compounds, which might also be coupled to the rotational mobility of the  $[\text{BH}_4]$  tetrahedra. These findings encourage further research activities towards solid-states conductors for Mg-ASSBs.

M. Heere (KIT);  
W. Lohstroh (FRM II)

### Read more

- [1] E. Hadjixenophontos et al., *Inorganics* 8, 17 (2020).  
doi:10.3390/inorganics8030017
- [2] Z. Zhao-Karger, M. Fichtner, *Front Chem* 6, 656 (2018).  
doi:10.3389/fchem.2018.00656.
- [3] E. Roedern et al., *Sci Rep* 7, 46189 (2017).  
doi:10.1038/srep46189
- [4] M. Heere et al., *Scientific Reports* 10, 9080 (2020).  
doi:10.1038/s41598-020-65857-6
- [5] W. Lohstroh, M. Heere, *Journal of the Physical Society of Japan* 89, 1-12 (2020).  
doi:10.7566/JPSJ.89.051011



## Dear colleagues,

being within the drastic societal changes and challenges due to the Corona pandemic, I hope to meet you, your families, friends and colleagues in good condition.

Our research at a large-scale facilities in user operation benefits largely from the advantages of free travel, international cooperation and exchange, and we tend to take this for granted. During the pandemic, the restricted situation has changed many workflows: Our responsibility for people's health dominates now. Surprisingly, our efforts for digital transformation and standardization are no longer only driven by clever ideas, enthusiasm, and political request, and show results. Remote experiments – “impossible” for some of us days ago – are speedily developed and will be technically excellent soon. Scientific exchange takes place per video conference, and some of us feel that less travel gives more time to work in-depth. Digitalisation adds a new dimension to our workflow. Nevertheless, remote work can not replace direct exchange. The best technique making a standard experiment possible by mailing in the sample and working remotely on the instrument computer will not displace the experience of experiments on-site, the personal exchange, inspiration, and learning effect, especially for young researchers. We look forward to having both in the future. It is up to us to select the most efficient, most successful way for each individual experiment.

Being sad about all the harm this pandemic brings to human-kind, let us answer thinking and working in a scientific manner – in all respects. Let us challenge our priorities, and accept the needs to reorganize our life to get a chance to tackle climate change, poorness, and diseases.

The activities of KFN are still dominated by digital transformation, cooperation within the scientific landscape, and strategic aspects of neutron scattering in Germany and Europe. The DAPHNE (DATA for PHoton and Neutron Experiments) proposal for NFDI that we submitted together with photon science got an excellent review but no funding yet. Together with all partners from universities and facilities, we will improve the proposal and re-apply. In parallel, the ErUM-Data initiative prepares for a BMBF-call. The cooperation of eight large-scale facility communities promises a fully new quality, as well as the initiatives between the research infrastructures on the European level. Synergy, joint effort, and efficient use of resources are the goals to strive for.



© W. Schürmann (TUM)

Astrid Schneidewind

Chair of the 11<sup>th</sup> KFN  
(Komitee Forschung mit Neutronen)

[a.schneidewind@fz-juelich.de](mailto:a.schneidewind@fz-juelich.de)

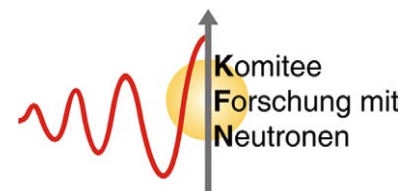

## Fuat Sezgin Award for PhD candidate at MLZ

PhD candidate Neslihan Aslan is doing research in the area of hydrogen storage. In January, the scientist was awarded the Fuat Sezgin Prize, which is offered by the Presidency for Turks Abroad (YTB) of the Turkish Ministry of Culture and Tourism.

For two years, PhD student Neslihan Aslan has been researching in the field of hydrogen storage at the Heinz Maier-Leibnitz Zentrum (MLZ) in Garching via the Technical University of Munich. “We are examining possibilities to store hydrogen inside solids, as for example in metal and complex hydrides, in order to save energy, space and costs”, the scientist explains her work. This is because hydrogen has to be cooled in an energy-intensive manner to store it in liquid form. Gaseous storage, in turn, requires large storage volumes. For her research Neslihan Aslan therefore carries out spectroscopic measurements on the TOFTOF instrument. She investigates the molecular movements of inorganic amides and boron hydrides, since these substances contain a high mass fraction of hydrogen. The measurements will provide more precise information on hydrogen release and absorption in solids.

In the summer of 2019, the young scientist became aware of the Fuat Sezgin Excellence Award Program announced by the Presidency for Turks Abroad (YTB). The prize commemorates the historian and Islamic

scholar Fuat Sezgin, who died in June 2018. After Turkey proclaimed the year 2019 as the “Prof. Dr. Fuat Sezgin Year”, the funding applies to bachelor’s or master’s students and PhD candidates of Turkish origin who are studying and researching outside Turkey and are performing very well. “At first I was sceptical whether I would be eligible for funding at all”, says Neslihan Aslan, who had studied in Regensburg and in Lille in France. Although the chemist has Turkish roots, she was born in Germany and has the German citizenship.

Nevertheless, the scientist has applied “at good luck”, as she says. The invitation to an interview in Munich was then a pleasant surprise. Representatives of the Turkish Ministry of Culture and Tourism travelled to the event, which took place in summer 2019.

In January 2020 Neslihan Aslan finally was able to celebrate the award – until now without an official award ceremony due to the corona pandemic. The Fuat Sezgin Excellence Award Program is endowed with a financial support of 3000 € for PhD candidates. For Neslihan Aslan the use of the prize money became clear very soon: the scientist donated one part to “Aktion Deutschland Hilft”, while the other part went on a long-awaited trip to the USA together with her siblings.

*T. Kiechle (FRM II)*

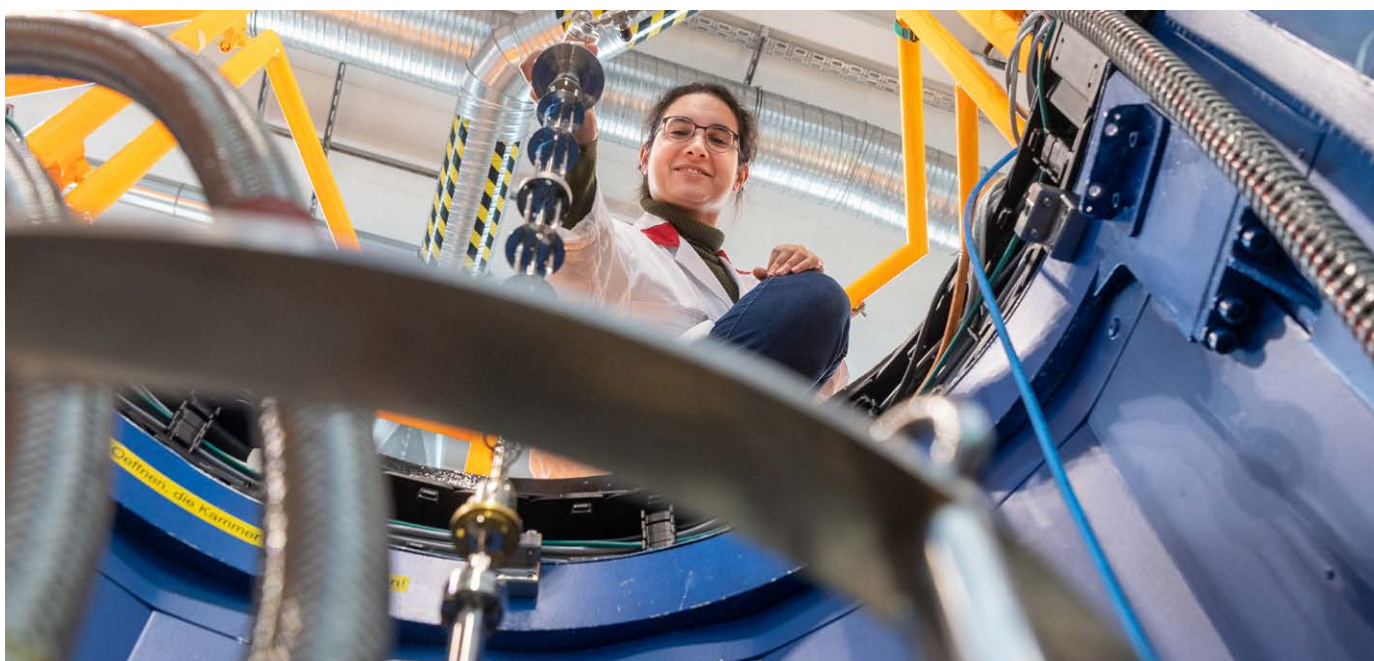

Neslihan Aslan inserting the sample stick into the cryostat at TOFTOF.

## Newly Arrived

I am **Jianhui Xu**, the new second instrument scientist on the cold three axes spectrometer MIRA. I obtained my PhD degree in TU Berlin and Helmholtz-Zentrum Berlin. I am interested to study the quantum magnetism in bulk materials using neutron scattering. In some materials, geometrical frustration of exchange interactions between magnetic moments suppresses the conventional long-range magnetic order and induces novel states of matter, such as spin ice and spin liquid. If interested, you can find more about my research in my article on *Order out of a Coulomb Phase and Higgs Transition: Frustrated Transverse Interactions of  $Nd_2Zr_2O_7$* : <https://doi.org/10.1103/PhysRevLett.124.097203>.



———— [Jianhui.Xu@frm2.tum.de](mailto:Jianhui.Xu@frm2.tum.de) —————

My name is **Martin Landesberger**, I joined the STRESS-SPEC team in December to develop and implement an optical tracking for high accuracy sample positioning with an industrial robot. This fits well in my mechanical engineering background. First contact to the MLZ was during my master's thesis and PhD project in which I had the chance to investigate phase transition kinetics in austempered ductile irons with neutron diffraction. Carbon localization, its diffusion, and the decomposition of phases in iron alloys are of special interest for me. I am originally from Landshut, 60 km away from Garching and absolute curious about new people, other opinions, and thoughts which I like to discuss in presence of a good Scotch Whisky – after work ;)



———— [Martin.Landesberger@frm2.tum.de](mailto:Martin.Landesberger@frm2.tum.de) —————

I'm **Christian Franz** and I joined the JCNS team of Forschungszentrum Jülich GmbH in Garching as instrument scientist for the thermal time-of-flight instrument TOPAS, which is currently under construction in the Neutron Guide Hall East. During the construction time of TOPAS, I will help to strengthen the PANDA team.

I obtained my PhD at the Technical University of Munich at the Chair for the Topology of Correlated Materials, where I investigated quantum phase transitions with lacking inversion symmetry and gained a background in crystal growth and lab measurement techniques. During the past years, I continued this work as a beamline scientist at the resonance spin echo spectrometer RESEDA, which we transformed into a longitudinal geometry.



Learn more about my former instrument RESEDA: <https://doi.org/10.1016/j.nima.2019.05.056>

———— [c.franz@fz-juelich.de](mailto:c.franz@fz-juelich.de) —————



## Newly Arrived

I'm **Jon Leiner** and I joined RESEDA as an instrument scientist/ PostDoc where I am upgrading its MIEZE capabilities for inelastic SANS measurements (the MIASANS project). This will involve installing new superconducting magnets for the resonant spin-flippers and a new small angle detector tank, as well as improving the neutron optics along the instrument beam path. I received my Ph.D. in Physics from the University of Notre Dame where I used neutron reflectometry to study magnetic semiconductor heterostructures. I subsequently worked at Oak Ridge National Laboratory and Seoul National University, where my main research focus has been the application of neutron spectroscopy to strongly correlated electron systems including topics such as frustrated magnetism and topological insulators.



One highlight of my research projects is the discovery of frustrated magnetism in paramagnetic  $V_2O_3$ , as described in <https://doi.org/10.1103/PhysRevX.9.011035>

---

**Jon.Leiner@frm2.tum.de**

---

My name is **Markos Skoulatos** and I am at the MLZ and TUM since six years, serving the MIRA community in the last four. My personal interests lie in condensed matter systems, and in particular magnetism and orbital physics. Through collaborators and users in the last decade, I have an overview of what is needed by the community, with respect to better organising and planning their experiments at the MLZ. Since June 2020, I have an extra role as head of the Materials Science Lab. Together with Teodora Kennel, I will work on updating the lab and ensuring easy access for all MLZ neutron users. I am keen to hear from all of you what you think is missing or what would be beneficial for your users to have in this lab, from your experience so far. Just get in contact with us!



Interested in my research? Just read about *Putative spin-nematic phase in  $BaCdVO(PO_4)_2$*  at <https://doi.org/10.1103/PhysRevB.100.014405>

---

**Markos.Skoulatos@frm2.tum.de**

---

I am **Alistair Cameron** and since January 2020, I have joined the PANDA team as the BAMBUS postdoc, responsible for completing and testing the new multidetector that is being developed on this instrument. After completing my PhD on the vortex lattice of unconventional superconductors at the University of Birmingham in 2014, I moved to the Technical University of Dresden as part of the group of Professor Inosov, where I remained until moving to MLZ. My research time is split between the study of superconductors and magnetism through the use of neutrons, with occasional forays into heavy fermion systems.



Learn something about the rotation of the magnetic vortex lattice in the superconductor  $Ru_7B_3$  at <https://doi.org/10.1103/PhysRevB.100.024518>

---

**alistair.cameron@tu-dresden.de**

---



warmly invite the  
neutron scattering community!



This year, the MLZ User Meeting will take place **Dec 08<sup>th</sup> to 09<sup>th</sup>** and is directly linked to the German Neutron Scattering Conference DN2020 on **Dec. 09<sup>th</sup> and 10<sup>th</sup>** which is hosted at Munich for the second time after 2008. A common poster session is going to link both meetings and will give the opportunity for exchange between the participants of both events.

**Abstract submission deadline: Aug. 01<sup>st</sup> • Registration deadline: Oct. 25<sup>th</sup>**



<https://indico.frm2.tum.de/e/um-2020-dn>

Please be aware that we are discussing the “How to” at the moment. We like to meet everybody in person but several of our users will have difficulties to travel and we still don’t know if there will be any restriction of the number of participants at the venue. Thus, we are planning to offer a mix of live and online presentations and are developing a concept for this. Due to possible changes on short notice, please have a close look at any reservation’s cancellation policy (hotel, flights)!

## Two new directors for the FRM II

Two new directors joined the FRM II: since March 01<sup>st</sup>, the fully trained lawyer, Robert Rieck (42), heads the administration department and since July 01<sup>st</sup> the physicist Axel Pichlmaier (51) heads the operation of the neutron source. Former administrative director Johannes Nußbickel had left the FRM II in December 2019. Anton Kastenmüller's – the previous technical director – second term ended according to rotation in March 2020. We have spoken with the two newcomers, who have in common their native city Munich.

### What has brought you to the FRM II?

**Axel Pichlmaier (AP):** The initial spark for my career was given by Klaus Schreckenbach in the lecture "Nuclear Solid State Physics" at the Technical University of Munich (TUM) in 1992. I became his working student at the Institut Laue Langevin (ILL) in Grenoble, France.

**Robert Rieck (RR):** During the past four and a half years, I have supported the water law permit of the FRM II on the part of the Technical University of Munich and thereby discovered my fascination for the neutron research source.



Robert Rieck.

### What is your background?

**RR:** I studied law at Ludwig-Maximilians Universität München (LMU). After my legal clerkship I worked as an independent lawyer. However, I always had a pas-

sion for public law. In my search for a position in the administration, I began in 2012 as a research assistant at the Hochschule für Politik München (HfP) and finally as permanent representative of the administrative director of the HfP since the take-over by the TUM.



Axel Pichlmaier.

**AP:** After my diploma thesis on the prototype positron source at the Atomic Egg, I also did my PhD on ultra-cold neutrons as a collaboration between TUM and ILL. I deepened my scientific experience at Los Alamos National Laboratory, USA, and the Paul Scherrer Institute, Switzerland. In 2008, I returned to Munich with TÜV Süd as an expert in reactor physics. I changed to the FRM II from 2011 until 2018 as head of the department for reactor operation and shutdown operation of the Atomic Egg. After being the deputy head of reactor operations at the ILL, now, I am back again in Garching.

### What are your goals at the FRM II?

**AP:** I want to continue operating the FRM II safely, as a service for science at the Heinz Maier-Leibnitz Zentrum. I also will use synergies between the European neutron sources, especially FRM II and ILL. And of course, there are major projects with far-reaching significance for the FRM II: the supply of fresh fuel, the disposal of spent fuel elements and the fuel conversion.

**RR:** I see my mission in maintaining and improving what works, in order to support research at the neutron source in the best possible way.

A. Voit (FRM II)



## Experiments and measurements – co-operation with MLZ

### User Committee members

#### Adrian Rennie (Chair)

Uppsala, Sweden

adrian.ennie@physics.uu.se

#### Sophie Combet (Deputy Chair)

Saclay, France

sophie.combet@cea.fr

#### Jens Gibmeier

Karlsruhe, Germany

jens.gibmeier@kit.edu

#### David Keeble

Dundee, U.K.

d.j.keeble@dundee.ac.uk

#### Luigi Paduano

Naples, Italy

luigi.paduano@unina.it

#### Diana Quintero Castro

Stavanger, Norway

diana.i.quintero@uis.no

#### Rainer Niewa (KFN Observer)

Stuttgart, Germany

rainer.niewa@iac.uni-stuttgart.de



© W. Schürmann (TUM)

*As I write these comments a major concern worldwide is pandemic illness caused by covid-19: the first thoughts are for the health of colleagues, collaborators, friends and families. Everyone will certainly be trying to ameliorate the situation for people affected directly by illness as well as the problems associated with enforced isolation. The community working at MLZ – both staff and visiting users will be anxious that scientific know-how and resources are applied in the best possible way for the common good. Important work can be performed to understand the disease and develop appropriate treatments. Advances in other areas of science and technology that are supported by neutrons and other facilities at MLZ are likely also to be of prime importance as recovery will have to be made everywhere from the global impact of shutdowns and travel restrictions.*

*For MLZ apart from the immediate effect of postponement of operations and experiments, there are other changes. Users from external laboratories have had to rely on electronic meetings, e-mail and telephones to maintain contact with staff at MLZ. People have been busy working from home in many fields. In the longer term there are likely to be on-going changes. Even with some easing of strict lock-down procedures, we may have to be-*

*come accustomed to some remote access to the facility. This could involve 'mail-in' of samples and participation in experiments from a distance using various networks. Workloads will be different and certainly not less than previously. Suggestions and comments as to how new ways of working can be made to be effective are welcome.*

*The User Committee, as always, welcomes comments about all aspects of the experience of users from making the application for beam time, through experiment planning and execution to the analysis and publication of results. The resumption of operations in January this year brought more comments than previously, and these are now being discussed in the committee and with MLZ staff. Sharing ideas that can lead to improvements is very helpful and is much appreciated. I look forward to receiving many more in the coming months, either directly or via any of the members of the committee.*

## Some news from the User Office

Due to the Corona Pandemic, the usually well-visited User Office became a Home Office. We do miss our users but we are in a very good position to do this, because apart from the travel reimbursement processes, everything is already done online in our line of work. In contrast, instrument scientists and technicians long or longed (depending on their affiliation) for coming back in order to get their work done: It is not that easy to transfer a small angle scattering machine into the private living room!

### Proposal Round 27

Before anyone of us even learned the name “Corona”, we called for proposals. It was a thrilling round this time, because it was the first one using our new online system GhOST. After the User Meeting in December, when we opened it for registrations, proposal submission under full load was the next milestone. We received 285 proposals and a lot of feedback from the users – and we solved many problems with this completely new system during the crucial phase: the last three days before the deadline...

On May 14<sup>th</sup>/15<sup>th</sup>, the review meeting took place. Normally a meeting in person at Munich Airport, with a nice dinner in the evening and a lot of chatting, it became a focussed online meeting. Everything went well and the next milestone of GhOST – the external reviewing process and its finalisation – could be reached.

Of the submitted 285 proposals we could accept 149 and of the requested 1683 days of beam time, the review panels allocated 899.

### MLZ News by post

With the start of GhOST, every user has now the opportunity to opt in for the MLZ News. It is always available online for everyone, but if you like to receive a printed copy by normal post, we are happy to send it. Just check “yes” in your profile for the MLZ News! Please note: the available newsletter was sent out using the database of our old system. This will be the last time we use it, so if you don’t opt in via GhOST, you will no longer be on the distribution list.

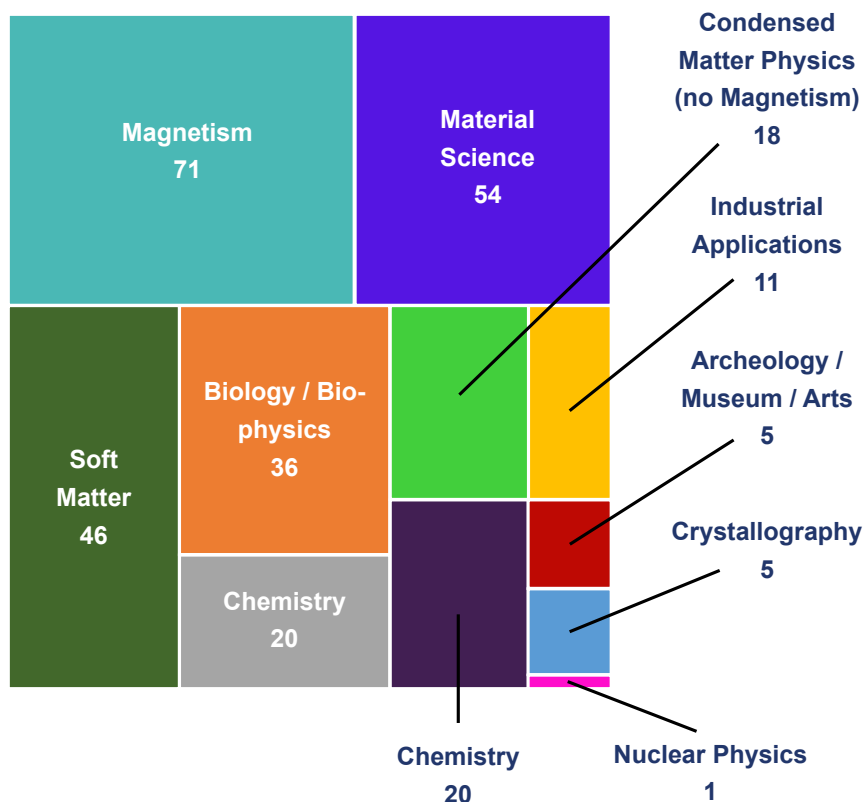

Within your profile, you can also opt in for the User Office circulars. There, we distribute news about proposal deadlines, MLZ events, and important information about our services. Just have a look!

Don't worry: For sure, you can always unsubscribe in your profile!

### New head of the MLZ User Office

After eight years as head of the MLZ User Office, Flavio Carsughi left and took up a new challenge at Forschungszentrum Jülich GmbH. His successor is Ina Lommatzsch, who had already been at the User Office for twelve years. Well known in the user community, she is looking forward to all her new tasks!

Scientific areas of submitted proposals in PR 27.



## Imprint

### Editors

Anke Görg  
Wiebke Lohstroh  
Ina Lommatzsch  
Stefan Mattauch  
Jürgen Neuhaus  
Andrea Voit

### Layout and typesetting

Ramona Bucher  
Ina Lommatzsch

July 2020

### Picture credits

If not indicated, all pictures:  
MLZ

### Contact

Forschungs-Neutronenquelle  
Heinz Maier-Leibnitz (FRM II)  
User Office

Lichtenbergstraße 1

85747 Garching, Germany

Phone: +49.(0)89.289.10794  
11751

Fax: +49.(0)89.289.10799

e-mail: [useroffice@mlz-garching.de](mailto:useroffice@mlz-garching.de)

[www.mlz-garching.de](http://www.mlz-garching.de)



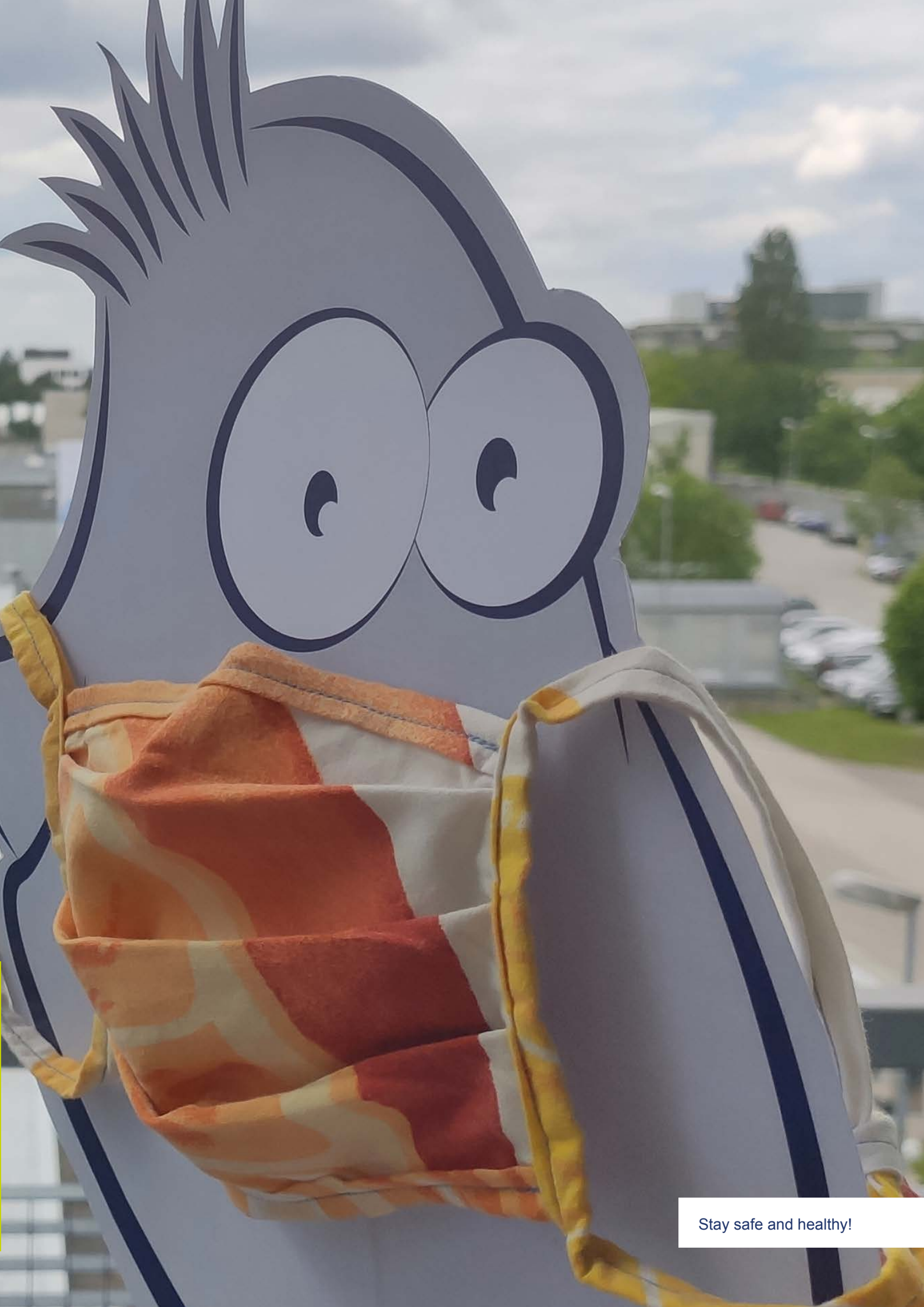

Stay safe and healthy!

**Do you like to receive  
the printed MLZ NEWS  
by post also in the future?**

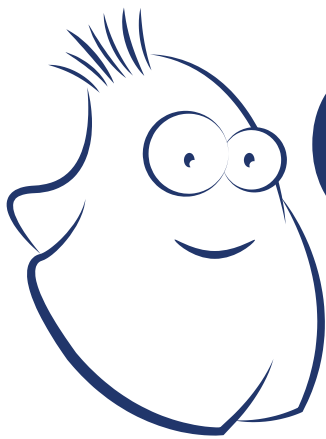

**GhOST**

Garching Online System Tool



**Yes**



**No**

**Don't forget to choose YES for MLZ News  
within your personal account  
at our online system ([ghost.mlz-garching.de](https://ghost.mlz-garching.de))!**